

# 2

# DEVELOPMENT STANDARDS FOR RESIDENTIAL PROJECTS

This Chapter presents the development standards for residential projects. Section 2.1 discusses the types of residential buildings appropriate within various zoning districts in the unincorporated areas of West Alameda County. In Sections 2.2 to 2.5, drawings are shown first to provide a summary of the major development standards in a visual format. Then a table listing all development standards follows. Standards that are in bold italics are existing County Zoning standards. This Chapter is organized by the following sections:

2.1 Residential Building Types: Appropriate Zones and Densities

2.2 Single-Family Subdivision and Hillside Standards

2.3 Small-Lot Single Family Home Standards

2.4 Townhome Standards

2.5 Multi-Family Residential Standards

# 2.1 Residential Building Types: Appropriate Zones and Densities

## Appropriate Zones and Densities

To ensure compatibility between new development and an existing neighborhood, new development should have densities that are appropriate to the building type and the existing density of the surrounding neighborhood.

**Policy 2-1:** Design projects consistent with the following table, which shows the appropriate density ranges for each building type and the zones that are appropriate for each building type. The table may be updated from time to time as new zoning districts are established.

The minimum building site per dwelling unit establishes the minimum developable lot area required for one dwelling unit. When calculating net density for single-family subdivisions, small-lot single family homes and townhomes, the following portions of the property are excluded from the calculation: private streets, access easements, stems, driveways that serve more than one lot, street parking spaces, and any other unservable or unbuildable portion of the lot. This applies to all single-family subdivisions, small-lot single family homes and townhomes, regardless if they are rental or for sale units. This does not apply to air space subdivisions or multi-family rental flats.

## Density Bonuses

A residential development that includes five or more dwelling units and meets one or more of the following criteria is entitled to a density bonus and one or more incentives under State Government Code Section 65915:

- (A) Ten percent of the total units of a housing development for lower income households, as defined in Section 50079.5 of the State Health and Safety Code.
- (B) Five percent of the total units of a housing development for very low income households, as defined in Section 50105 of the State Health and Safety Code.
- (C) A senior citizen housing development, as defined in Sections 51.3 and 51.12 of the State Civil Code, or mobilehome park that limits residency based on age requirements for housing for older persons pursuant to Section 798.76 or 799.5 of the Civil Code.
- (D) Ten percent of the total dwelling units in a common interest development as defined in Section 1351 of the State Civil Code for persons and families of moderate income, as defined in Section 50093 of the State Health and Safety Code, provided that all units in the development are offered to the public for purchase.

**TABLE 2.1-1: RESIDENTIAL MAXIMUM DENSITIES AND APPROPRIATE ZONES**

ACBD: Ashland and Cherryland Business District Specific Plan / CVCBD: Castro Valley Central Business District Specific Plan				
<b>Building Type</b>	<b>Appropriate Zones</b>	<b>Minimum Building Site (Square Feet) Per Dwelling Unit<sup>1</sup></b>	<b>Maximum Net Density (Dwelling Units/Acre)<sup>2</sup></b>	<b>Notes</b>
<b>SINGLE-FAMILY SUBDIVISION</b>	R-1	5,000	8.7	
	R-1-B Combining	8,000 – 40,000	1.1 – 5	Or as specified in the zoning amendment creating the district.
<b>HILLSIDE DEVELOPMENT</b>	R-1	5,000	8.7	
	R-1-B Combining	8,000 – 40,000	1.1 – 5	Or as specified in the zoning amendment creating the district.
	R-1-Hillside (Castro Valley Draft General Plan)	5,000 – 10,000	4 – 8.7	
	Fairview Specific Plan	5,000 – 1 acre	1.0 – 6.0	Maximum densities per the Fairview Specific Plan.
	Madison Area Specific Plan	5,000 – 40,000	1.1 – 8.7	Maximum densities are set by the Madison Area Specific Plan.
<b>SMALL-LOT SINGLE FAMILY</b>	R-S	5,000	8.7	
	R-S-D35	3,500	12.4	
	R-S-DV	3,500	12.4	With lot width less than 100 feet and lot area less than 20,000 square feet.
				If the width of a project site is less than 60 feet, the maximum number of small-lot single-family units allowed on the site is two and the minimum area per two small-lot single-family residential dwelling units is 7,500 square feet.
<b>TWO-STORY TOWNHOMES</b>	R-S-D35	3,500	12.4	
	R-S-DV	3,500	12.4	With lot width less than 100 feet and lot area less than 20,000 square feet.
	R-S-D3	2,500 – 3,000	14.5	As specified in the zoning amendment creating the district.
	R-S-D25	2,500	17.4	
	R-2	2,500	17.4	

Table 2.1-1: Residential Maximum Densities and Appropriate Zones

ACBD: Ashland and Cherryland Business District Specific Plan / CVCBD: Castro Valley Central Business District Specific Plan					
<b>Building Type</b>	<b>Appropriate Zones</b>	<b>Minimum Building Site (Square Feet) Per Dwelling Unit<sup>1</sup></b>	<b>Maximum Net Density (Dwelling Units/Acre)<sup>2</sup></b>	<b>Notes</b>	
<b>THREE-STORY TOWNHOMES</b>	R-S-D25	2,500	17.4		
	R-2	2,500	17.4		
	R-S-D3	2,000 – 2,500	21.8	As specified in the zoning amendment creating the district.	
	R-S-D20	2,000	21.8		
	R-S-DV	2,000	21.8	With lot width more than and equal to 100 feet and lot area more than or equal to 20,000 square feet.	
	R-3	2,000	21.8		
<b>MULTI-FAMILY RESIDENTIAL MEDIUM DENSITY</b>	R-S-D20	2,000	21.8		
	R-3	2,000	21.8		
	R-S-DV	2,000	21.8	With lot width more than and equal to 100 feet and lot area more than or equal to 20,000 square feet.	
	R-S-D15	1,500	29.0		
	R-S-D3	1,500 – 2,000	21.8 – 29.0	As specified in the zoning amendment creating the district.	
	ACBD-RC (Residential/ Commercial)		15 – 25	Residential uses may be developed without commercial uses.	
	CVCBD Land Use Group D Subareas 4, 5, 6, 7, 11		2,500	17.4	With minimum lot size of 10,000 to 20,000 square feet.
			2,000	21.8	With minimum lot size greater than 20,000 square feet.
	Not allowed along Castro Valley Boulevard in Subareas 5, 6, 7  Subarea 7 Limitations: Allowed along side street frontage depending on factors such as specific use, design, adjacent uses, etc. Not allowed along Redwood.			20 – 40	Allowed where a development is substantially composed of units aimed at the elderly or handicapped, where units are mostly studios or one bedroom units, where the parcel is large enough that higher density development can successfully occur, where surface parking is minimized through parking structures, underground parking, etc, or where development is immediately adjacent to the BART station or intensive commercial development.

Table 2.1-1: Residential Maximum Densities and Appropriate Zones

ACBD: Ashland and Cherryland Business District Specific Plan / CVCBD: Castro Valley Central Business District Specific Plan				
<b>Building Type</b>	<b>Appropriate Zones</b>	<b>Minimum Building Site (Square Feet) Per Dwelling Unit<sup>1</sup></b>	<b>Maximum Net Density (Dwelling Units/Acre)<sup>2</sup></b>	<b>Notes</b>
<b>MULTI-FAMILY RESIDENTIAL HIGH DENSITY</b>	R-4	1,250 – 1,000	34.5 – 43.5	
	CVCBD Land Use Group E Subareas 8, 9 Subarea 9 Limitations: Allowed on parcels west of Redwood Road only.		40 – 60	

Notes:

1. The minimum building site per dwelling unit establishes the minimum developable lot area required for one dwelling unit.
2. When calculating net density for single-family subdivisions, small-lot single family homes and townhomes, the following portions of the property are excluded from the calculation: private streets, access easements, stems, driveways that serve more than one lot, street parking spaces, and any other unservable or unbuildable portion of the lot. This applies to all single-family subdivisions, small-lot single family homes and townhomes, regardless if they are rental or for sale units. This does not apply to air space subdivisions, or to multi-family flats.

## 2.2 Single-Family Structures, Subdivisions, and Hillside Development Standards

This section presents the development standards for single-family home subdivisions, and includes a special section related to hillside development.

The purpose of the single-family subdivision and hillside standards is to preserve single-family neighborhoods and ensure that new development is consistent in scale with existing neighborhoods.

Single-family homes are detached homes on lots that range from 5,000 to 40,000 square feet in the unincorporated areas of West Alameda County.

These standards apply in the R-1 Zoning District, where detached single-family homes can be developed. San Lorenzo is predominantly zoned R-1, as are Castro Valley and Fairview.

In Castro Valley and Fairview hillside areas, parcels zoned R-1 may also have a combing B district zoning designation, which modify the site area and yard requirements. In addition, the Fairview area is governed by the Fairview Specific Plan and the Madison area in Castro Valley is governed by the Madison Area Specific Plan.



Figure 2.2-1: Single-Family Residential R-1: Summary of Major Development Standards

NOTE: Diagrams not to be used for density calculations.

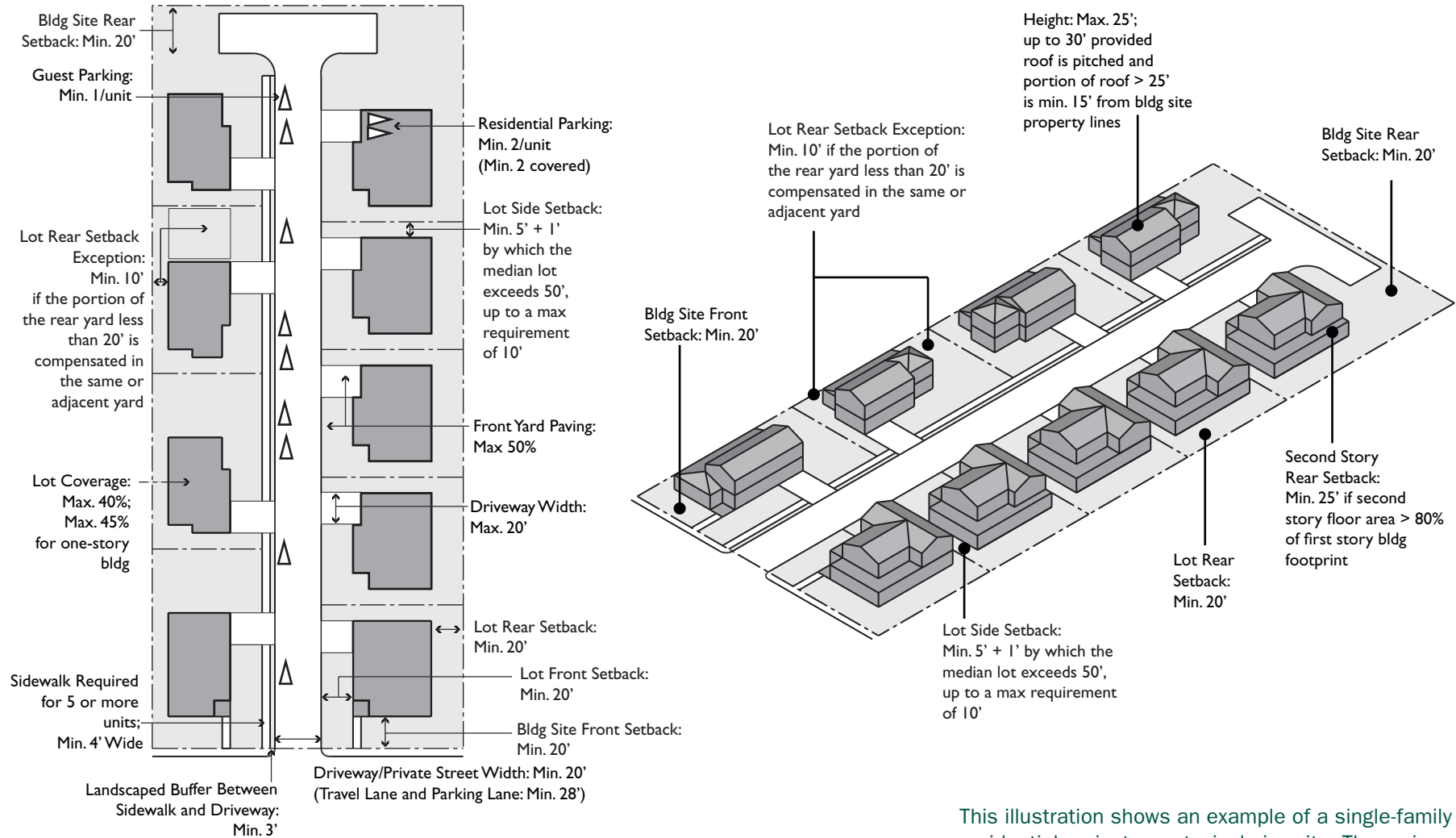

This illustration shows an example of a single-family residential project on a typical size site. The major development standards are indicated by text labels. Projects located in State Responsibility Fire Areas may be required to meet additional Fire Department standards.



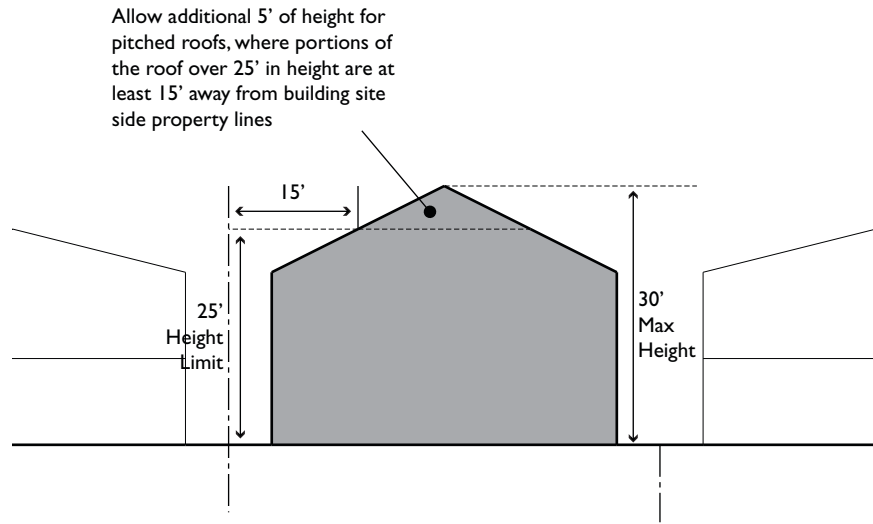
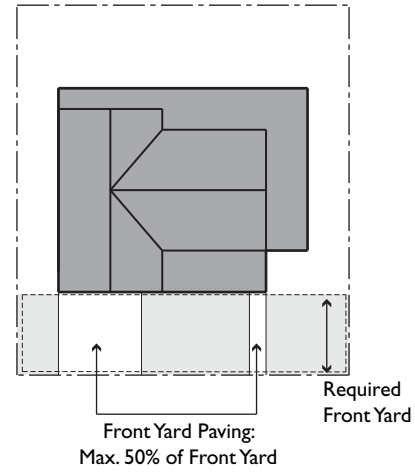

Figure 2.2-2: Single-Family Residential: Front Yard Paving



Projects located in State Responsibility Fire Areas may be required to meet additional Fire Department standards.

Figure 2.2-3: Single-Family Residential: Front Porch or Covered Recess

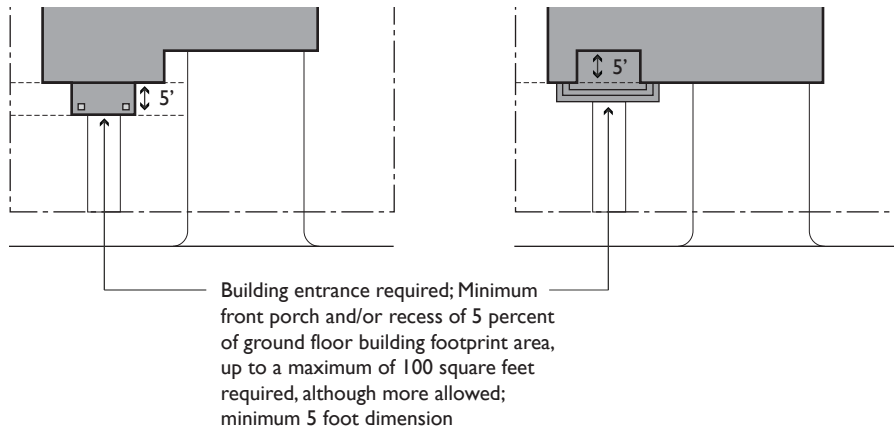

Figure 2.2-4: Single-Family Residential: Garages

For garages with three or more doors, or designed to accommodate three or more non-tandem parked cars see design guidelines section.

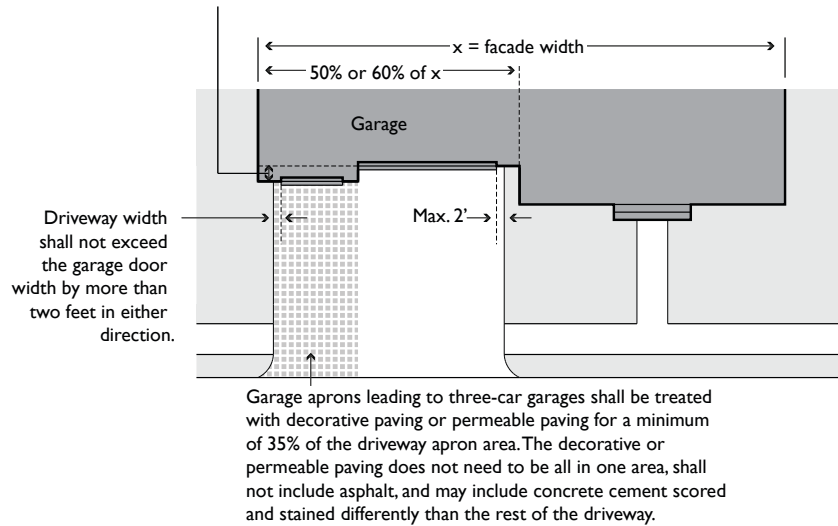
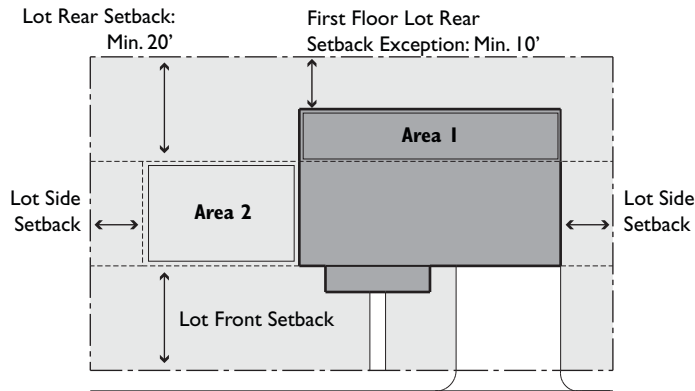

Figure 2.2-5: Single-Family Residential: First Story Lot Rear Setback Exception



First Story Lot Rear Setback Exception: First Floor Rear setback may be a minimum of 10' if that portion of the rear yard less than 20' in depth (Area 1) is compensated by open area within the same or adjacent yards on the same building site that exceed side and rear yard requirements by an area (Area 2) at least equal to extent of building coverage of the 20' rear yard ( $\text{Area 2} \geq \text{Area 1}$ ). The minimum dimension of Area 2 is 10'.

Projects located in State Responsibility Fire Areas may be required to meet additional Fire Department standards.

Figure 2.2-6: Single-Family Residential: Flag Lot

NOTE: Diagrams not to be used for density calculations.

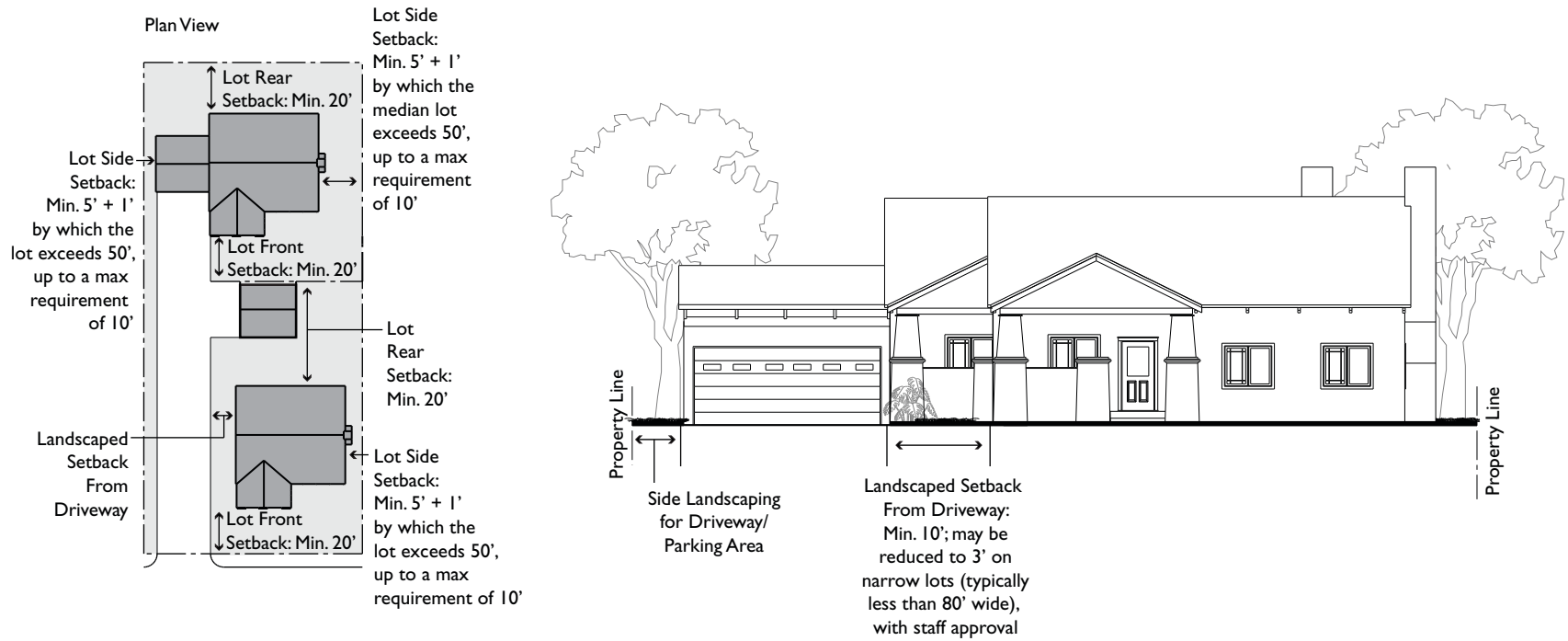

**TABLE 2.2-1: SINGLE-FAMILY SUBDIVISION STANDARDS**

<b>Standard<sup>1</sup></b>	<b>R-1</b>	<b>-B-8</b>	<b>-B-10</b>	<b>-B-20</b>	<b>-B-40</b>	<b>Additional Standards</b>
<b>DEVELOPMENT INTENSITY AND NEIGHBORHOOD COMPATIBILITY</b>						
Minimum Building Site and Lot Size (sq ft)	5,000	8,000	10,000	20,000	40,000	In addition, Castro Valley and Fairview require consistency with existing development in the area. See Chapter 7: Lot Size Consistency.
Minimum Lot Width (ft)	50	80	100	150	150	
Minimum Lot Width, Corner Lot (ft)	60					
Maximum Lot Coverage (%)	40	40	40	40	40	
One-Story Building (%)	45	45	45	45	45	
<b>BUILDING HEIGHT AND FORM</b>						
Maximum Height (ft)	25	25	25	25	25	The building height limitation does not apply to chimneys, church spires, flag poles, or to mechanical appurtenances necessary and incidental to the permitted use of a building.
Height Exception (ft)	Up to 30	Up to 30	Up to 30	Up to 30	Up to 30	Provided that the roof is pitched and the portion of the roof over 25 feet in height is at least 15 feet away from building site property lines. See Figure 2.2-2.
Maximum Stories	2	2	2	2	2	
Maximum Second Story Floor Area (%) (Percentage of First Story Building Footprint)	80	80	80	80	80	The second story cannot exceed 80 percent of the first story building footprint area.
<b>BUILDING RELATIONSHIP TO STREET</b>						
Maximum Front Yard Paving (%)	50	50	50	50	50	See Figure 2.2-3.
Street Facing Façade Design	Required. Street facing facades must be designed to orient towards the public street, or private street if lot does not abut public street. Windows, entry door, and other elements must be incorporated to create an attractive street appearance that enhances the surrounding neighborhood.					
Building Entrances on Streets	Required. The principal entry shall be located in a visible location from the public street, or private street if lot does not abut public street.					
Covered Front Porch or Covered Recessed Entry	Required.					
Minimum Depth (ft)	5	5	5	5	5	Alternative designs that create a welcoming entry feature visible from the street, such as a trellis or landscaped courtyard entry may be approved by Staff. See Figure 2.2-4.
Minimum Area of Porch and/or Recessed Entrance (sq ft)	5 percent of the first story building footprint area; up to a maximum of 100 square feet					

Table 2.2-1: Single-Family Subdivision Standards

<b>Standard<sup>1</sup></b>	<b>R-1</b>	<b>-B-8</b>	<b>-B-10</b>	<b>-B-20</b>	<b>-B-40</b>	<b>Additional Standards</b>
<b>SETBACKS FOR LIGHT AND AIR</b>						
Minimum Setbacks (ft)						Building site setbacks apply along the perimeter of a building site and lot setbacks apply to individual lots within a building site. In the event of conflict between building site setback requirements and lot setback requirements, the project must comply with whichever standard results in the greater setback.  Projects located in State Responsibility Fire Areas must maintain a 30 feet setback to other structures and property lines. Additional setbacks may be required from creeks and riparian corridors.
<b>Building Site (ft)</b>						
Front (Facing Public Street)	20	25	30	30	30	Must be landscaped.
Side (Facing Adjacent Neighboring Property)	5' + 1' for each full 10' by which the building site width exceeds 50', up to a maximum requirement of 10'	10	15	15	20	For R-1: Lot Width < 60' = Side Setback 5' Lot Width < 70' = Side Setback 6' Lot Width < 80' = Side Setback 7' Lot Width < 90' = Side Setback 8' Lot Width < 100' = Side Setback 9' Lot Width ≥ 100' = Side Setback 10'
Rear (Facing Adjacent Neighboring Property)	20	20	20	20	20	
<b>Lot (ft)</b>						
Front	20	25	30	30	30	Must be landscaped.
Side	5' + 1' for each full 10' by which the lot width exceeds 50', up to a maximum requirement of 10'	10	15	15	20	For R-1: Lot Width < 60' = Side Setback 5' Lot Width < 70' = Side Setback 6' Lot Width < 80' = Side Setback 7' Lot Width < 90' = Side Setback 8' Lot Width < 100' = Side Setback 9' Lot Width ≥ 100' = Side Setback 10'
Side, Corner	10					
Rear	20	20	20	20	20	

Table 2.2-1: Single-Family Subdivision Standards

<b>Standard<sup>1</sup></b>	<b>R-1</b>	<b>-B-8</b>	<b>-B-10</b>	<b>-B-20</b>	<b>-B-40</b>	<b>Additional Standards</b>
First Story Exception	10	10	10	10	10	Rear yard setback may be a minimum of 10 feet if that portion of the rear yard less than 20 feet in depth is compensated by open area within the same or adjacent yards on the same building site that exceed side and rear yard requirements by an area at least equal to extent of building coverage of the 20 feet rear yard with a minimum dimension of 10 feet. See Figure 2.2-6.
Second Story Exception	25	25	25	25	25	The second story is required to be set back a minimum of 25 feet from the rear property line if the second story exceeds 80 percent of the first story building footprint.
Setback From Access Driveway (ft)	10	10	10	10	10	Must be landscaped.
Setback From Access Driveway Exception (ft)	3	3	3	3	3	Landscaped setback from access driveway may be reduced to 3 feet on narrow building sites (typically less than 80 feet wide), with Staff approval. See Figure 2.2-7.
<b>AUTO CIRCULATION: SITE ACCESS AND DRIVEWAYS</b>						
Minimum Access Driveway/ Private Street Width (ft)	20	20	20	20	20	
Minimum Access Driveway/ Private Street Width Exception (ft)	12	12	12	12	12	Minimum 12 feet if lots are narrow and driveways serve fewer than 5 units. Fire Department may consider this exception if the rear-most corner of the rear-most building is within 150 feet of the curb and alternative means and methods are incorporated to meet Fire Code safety objectives.
Minimum Driveway Gates Setback (ft)	20	20	20	20	20	Gates are strongly discouraged. Gates across driveways shall be set back a minimum of 20 feet behind the property line, or greater depending on location in State Responsibility Fire Area and street travel speed.
<b>PARKING LOCATION AND DESIGN</b>						
Maximum Garage Width (ft)						See Figure 2.2-5.
Facing Public Street	Where garage doors face a public street, garage width shall not exceed 50 percent of the width of the front façade of the building.					
Facing Access Driveway/Private Street	Where garage doors face a private street or access driveway, garage width shall not exceed 60 percent of the width of the front façade of the building.					
For garages with three or more doors, or designed to accommodate three or more non-tandem parked cars see design guidelines section.						

Table 2.2-1: Single-Family Subdivision Standards

<b>Standard<sup>1</sup></b>	<b>R-1</b>	<b>-B-8</b>	<b>-B-10</b>	<b>-B-20</b>	<b>-B-40</b>	<b>Additional Standards</b>
Maximum Driveway Apron Width (ft)	Driveway apron width shall not exceed the garage door width by more than one foot in either direction.					Garage aprons leading to three-car garages shall be treated with decorative or permeable paving for a minimum of 35 percent of the driveway apron area.
Unit Parking (per dwelling unit)	2	2	2	2	2	Minimum of two spaces must be covered spaces in a garage or carport.
Guest Parking (per dwelling unit)	1	1	1	1	1	Space along the public street frontage of a building site can be counted towards guest parking requirements. However, guest spaces may be required to be on the building site if there is existing parking congestion, as defined by the Planning Director, on the street. A parking study may be required to determine existing parking congestion. Driveway aprons are not counted towards the required guest parking of a private single-family subdivision development.
<b>FACILITIES FOR PEDESTRIANS, BICYCLES, AND TRANSIT</b>						
Pedestrian Walkway Next to Access Driveway/Private Street	Required for 5 units or more					
Minimum Width of Pedestrian Walkway (ft)	4	4	4	4	4	
<b>SITE LANDSCAPING</b>						
Minimum Width of Landscaped Buffer Between Pedestrian Walkway and Access Driveway/Private Street (ft)	3	3	3	3	3	
Minimum Side Landscaping for Access Driveway/Private Street/Parking Area (ft)	5					Applies between the access driveway/private street/parking areas and the building site side and rear property lines.
Minimum Side Landscaping Exception (ft)	3					The minimum side landscaping shall be 3 feet when the building site width is less than 80 feet. Staff may approve a minimum side landscaping of 3 feet for building sites that are 80 feet or wider if vertical landscaping (e.g. trees, shrubs, bushes) is planted along this side landscaping area.

Note:

<sup>1</sup> For the -B-E Combining District, standards are as specified in the amendment creating the district.



## **Additional Hillside Standards**

This sub-section presents additional development standards for single-family home subdivisions in hillside areas.

The goal for the additional hillside standards is to ensure that hillside development is consistent in scale with existing neighborhoods and to ensure that height is minimized through development that steps down the hillside, following the slope of the land.

Figure 2.2-7: Single-Family Residential R-1 Hillside: Summary of Additional Major Development Standards

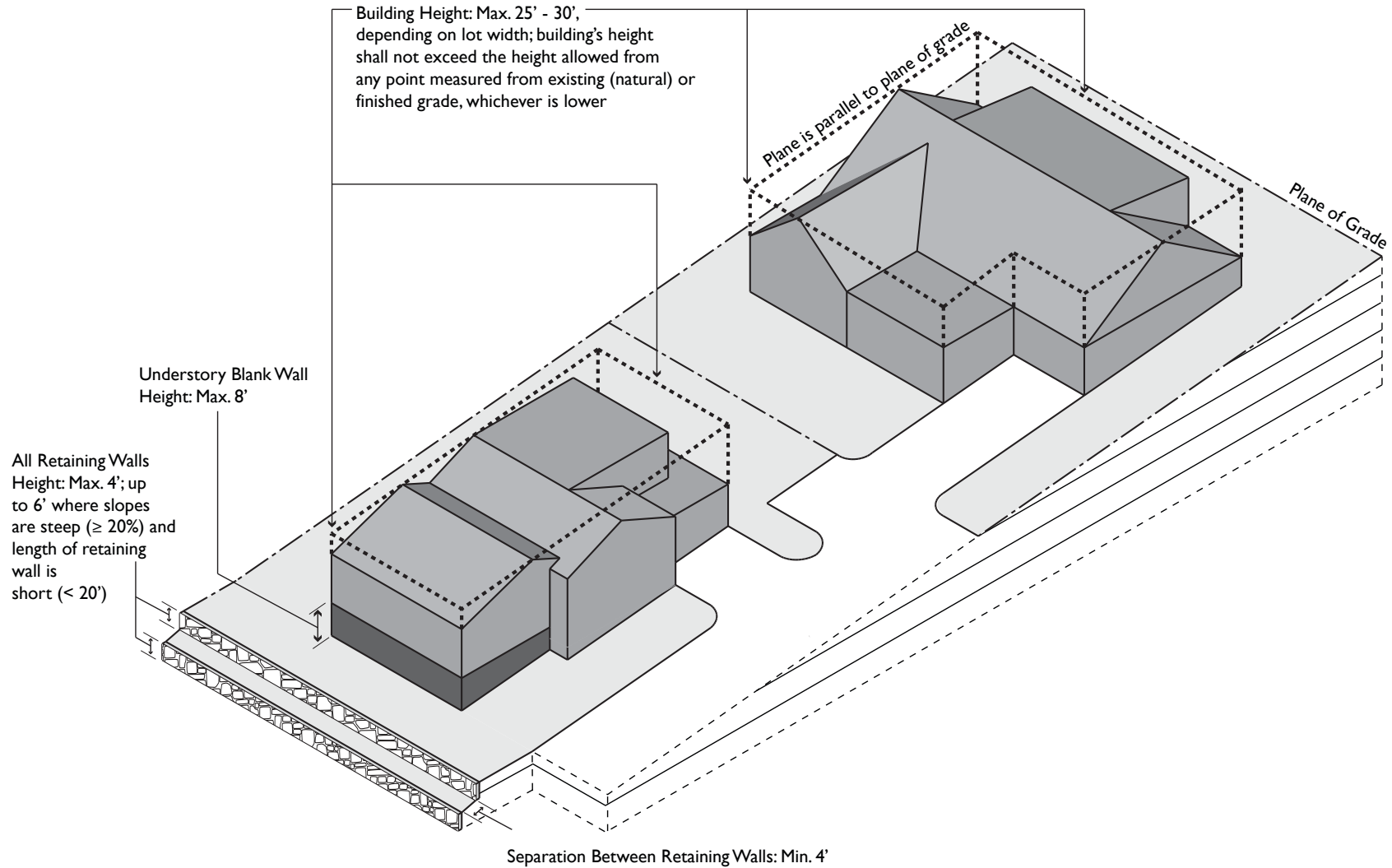
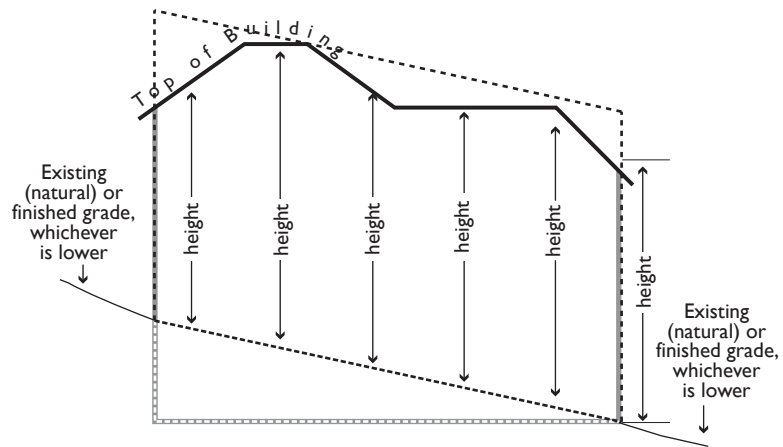
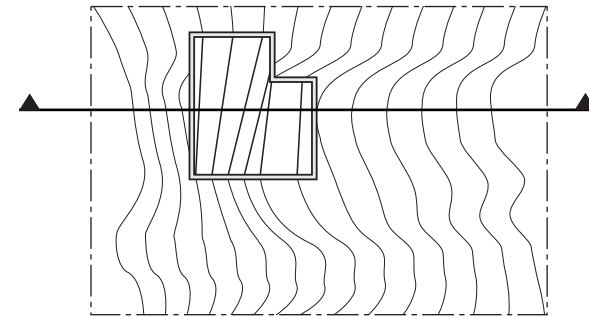

Figure 2.2-8: Single-Family Residential Hillside: Height



Cross-sectional illustration



Plan View

When finished grade is lower than existing (natural) grade:

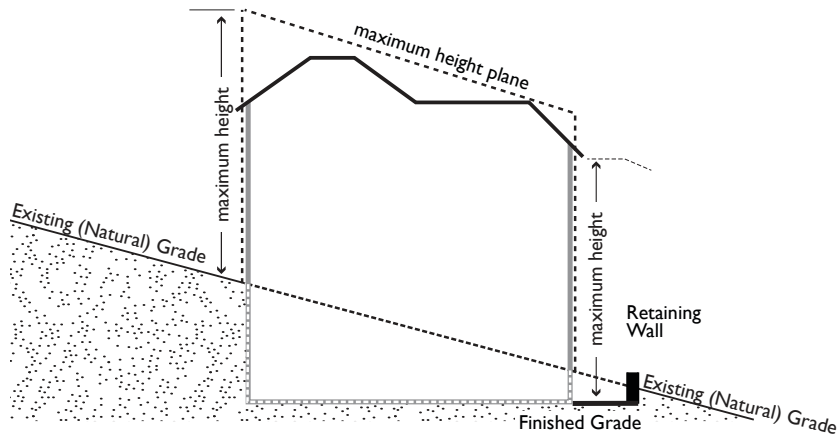

Finished grade is lower than existing (natural) grade so height is measured from finished grade

When existing (natural) grade is lower than finished grade:

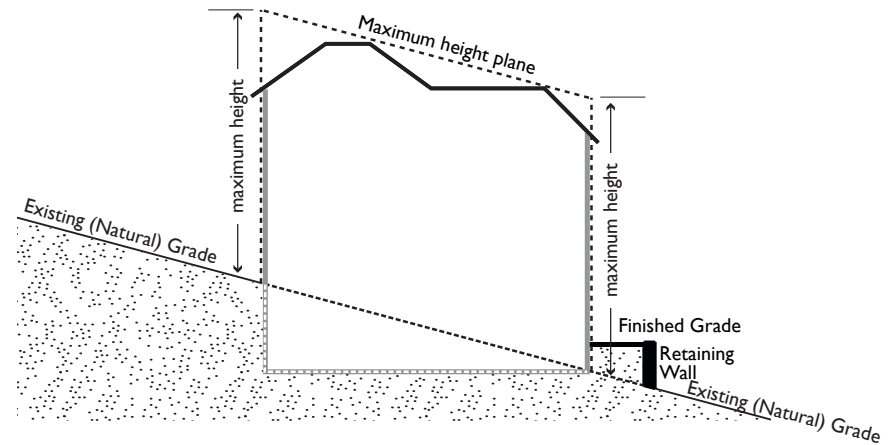

Existing (natural) grade is lower than finished grade so height is measured from existing (natural) grade

Figure 2.2-9: Single-Family Residential Hillside: Retaining Wall Height

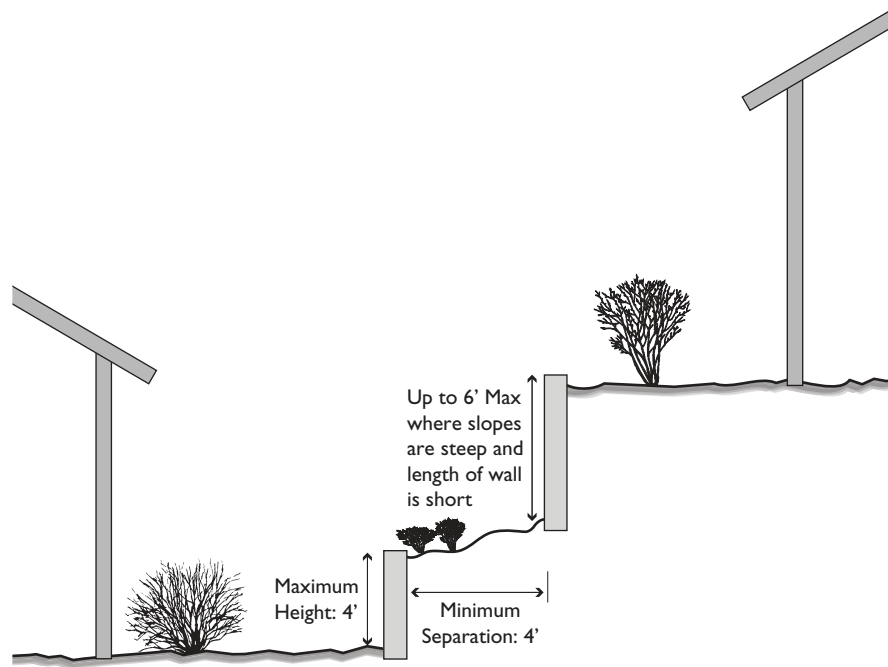

**TABLE 2.2-2: ADDITIONAL REGULATIONS FOR HILLSIDE LOTS**

<b>Standard</b>	<b>R-1<sup>1</sup></b>	<b>Madison Area Specific Plan</b>	<b>Fairview Area Specific Plan</b>	<b>Additional Standards</b>
	(Sites with average slope exceeding 10% gradient)	R-1, R-1-B-E, PD	R-1, R-1-B-E (Sites with average slope exceeding 10% gradient)	
<b>DEVELOPMENT INTENSITY AND NEIGHBORHOOD COMPATIBILITY</b>				
Minimum Building Site and Lot Size (sq ft)	5,000	5,000 - 40,000	5,000 - 5 acres	In addition, Castro Valley and Fairview require consistency with existing development in the area. See Chapter 7: Lot Size Consistency.
Maximum Slope of Building Site (%)	< 30	< 30	< 30	Locate buildings outside the areas of a parcel that has a slope of 30 percent or greater.
Minimum Lot Width (ft)	50			
Minimum Lot Width, Corner Lot (ft)	60			
Maximum Lot Coverage (%)	40		20 - 40	
One-Story Building (%)	45			
<b>BUILDING HEIGHT AND FORM</b>				
Maximum Height (ft)	25	25	25	Building height shall not exceed the height allowed from any and all points measured vertically from the structure perimeter at existing or finished grade, whichever is lower. The allowed structure height shall be at or below that imaginary plane located vertically above all of the points measured from the structure perimeter at existing or finished grade, whichever is lower. See Figure 2.2-9.
Height Exception (ft)	Up to 30	Up to 30	Up to 30	Provided that the roof is pitched and the portion of the roof over 25 feet in height is at least 15 feet away from building site property lines. See Figure 2.2-2.
Maximum Stories	2	2	2	Larger size homes shall incorporate a variety of roof forms and step down at the outer edges of the building.

Table 2.2-2: Additional Regulations for Hillside Lots

<b>Standard</b>	<b>R-1<sup>1</sup></b>	<b>Madison Area Specific Plan</b>	<b>Fairview Area Specific Plan</b>	<b>Additional Standards</b>
	(Sites with average slope exceeding 10% gradient)	R-1, R-1-B-E, PD	R-1, R-1-B-E (Sites with average slope exceeding 10% gradient)	
Stories Exception	3	3	3	
	Where the natural ground slope of a lot on the downhill side of the street is greater than one foot in seven feet as measured from the front lot line to the grade at the rear wall of the proposed building, one story in addition to the number permitted in the district in which the lot is situated is permitted on the downhill side of any building. The building height shall not otherwise exceed the limit specified for said district.			
<b>SETBACKS FOR LIGHT, AIR AND PRIVACY</b>				
Minimum Project and Lot Setbacks (ft)				Projects located in State Responsibility Fire Areas must maintain a 30 feet setback to other structures and property lines. Additional setbacks may be required from creeks and riparian corridors.
Front	Same as Standards in Table 2.2-1 for R-1	See Special Setbacks in Specific Plan	15 - 30 (As specified in the Specific Plan)	Must be landscaped.
Side	Same as Standards in Table 2.2-1 for R-1	Average 20; Minimum 10 See Special Setbacks in Specific Plan		
Rear	Same as Standards in Table 2.2-1 for R-1	Same as Standards in Table 2.2-1 for R-1	Same as Standards in Table 2.2-1 for R-1	
<b>USABLE OPEN SPACE</b>				
Minimum Private Usable Open Space (sq ft)			1,000	Private, usable open space area is considered: <ul style="list-style-type: none"> <li>• Areas not visible from the fronting street;</li> <li>• Areas with a ground slope of less than 20 per cent gradient;</li> <li>• Areas not covered by off street parking or any access thereto;</li> <li>• Any open area with a minimum 15 feet in its least dimension; and</li> <li>• Roof-top areas designed for outdoor residential use or outside deck spaces more than 8 feet in least dimension.</li> </ul>
Minimum Ground Floor Dimension (ft)			15	
Minimum Deck/Balcony Dimension (ft)			8	

Table 2.2-2: Additional Regulations for Hillside Lots

<b>Standard</b>	<b>R-1<sup>1</sup></b>	<b>Madison Area Specific Plan</b>	<b>Fairview Area Specific Plan</b>	<b>Additional Standards</b>
	(Sites with average slope exceeding 10% gradient)	R-1, R-1-B-E, PD	R-1, R-1-B-E (Sites with average slope exceeding 10% gradient)	
<b>WALLS</b>				
Maximum Height of Understory Blank Walls (ft)	8	8	8	
Maximum Retaining Wall Height (ft)	4 - 6	4 - 6	4 - 6	See Figure 2.2-9.
	Limit the height of all retaining walls to four feet, and require a minimum four-foot horizontal separation between retaining walls. Allow up to six feet retaining walls in special circumstances where slopes are steep (greater than or equal to 20 percent) and the length of the retaining wall is short (less than 20 feet in length.)			

Note:

<sup>1</sup> For the -B-E Combining District in areas outside of the Fairview and Madison Area Specific Plan areas, standards are as specified in the amendment creating the district.

*Page Intentionally Left Blank*



## 2.3 Small-Lot Single-Family Home Standards

This section presents the development standards for small-lot single-family homes.

The purpose of the small-lot single-family home standards is to allow for a variety of housing types in the unincorporated areas of West Alameda County while also achieving neighborhood goals for an attractive street appearance. The standards are also to ensure that basic needs for sunlight, privacy, ventilation, recreation area and parking are provided.

Small-lot single-family homes are detached units that are typically smaller than single-family homes and require a minimum building site of 3,500 to 5,000 square feet per dwelling unit.

Small-lot single-family homes are appropriate in the R-S, R-S-D35, and R-S-DV Zoning Districts. These districts are located in Cherryland and Hayward Acres.



Figure 2.3-1: Small-Lot Single-Family Homes: Summary of Major Development Standards

Note: Diagrams not to be used for density calculations.

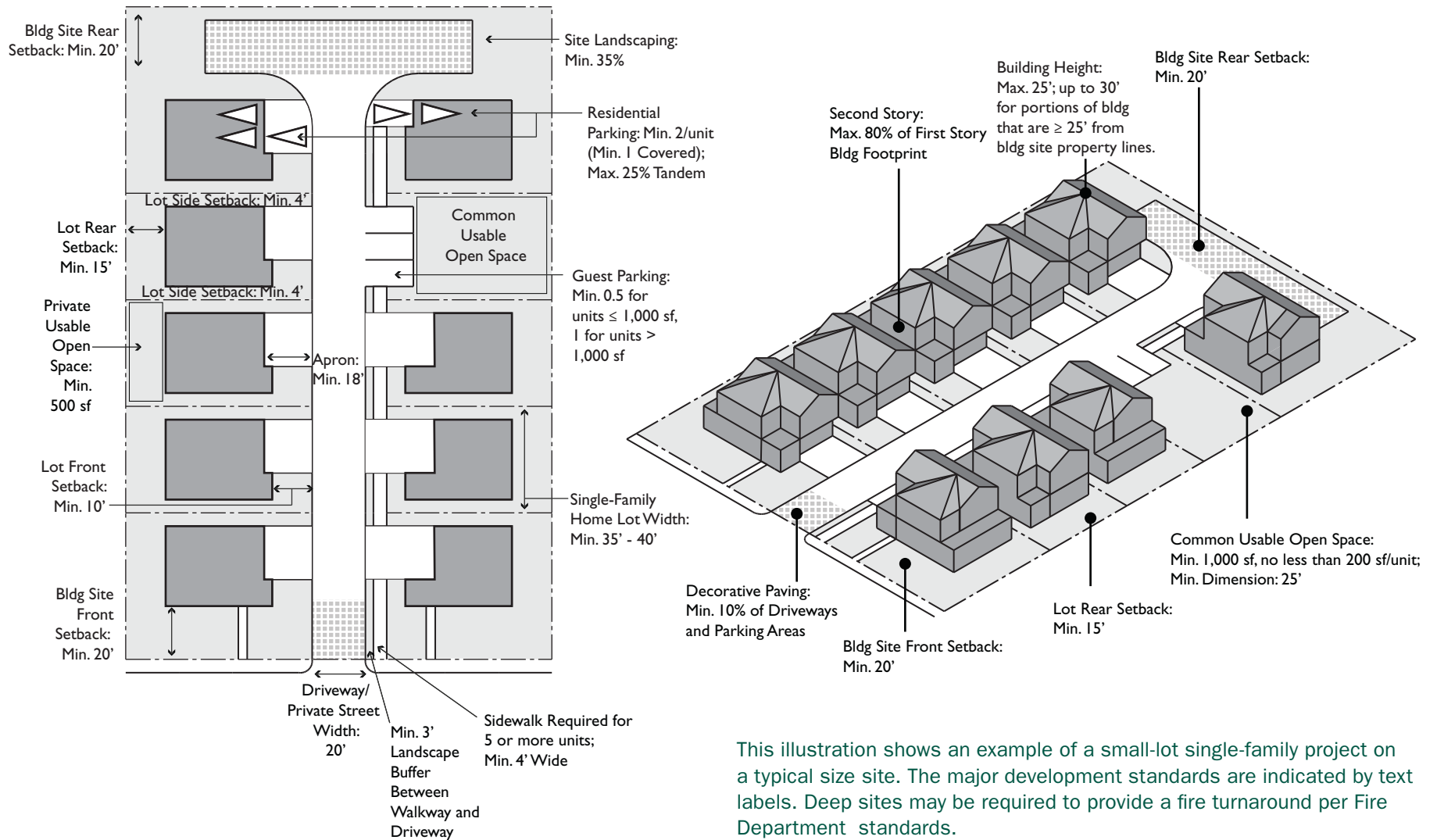

This illustration shows an example of a small-lot single-family project on a typical size site. The major development standards are indicated by text labels. Deep sites may be required to provide a fire turnaround per Fire Department standards.

Figure 2.3-2: Small-Lot Single-Family Homes: Narrow Lot (60' to 75' Wide): Summary of Major Development Standards

Note: Diagrams not to be used for density calculations.

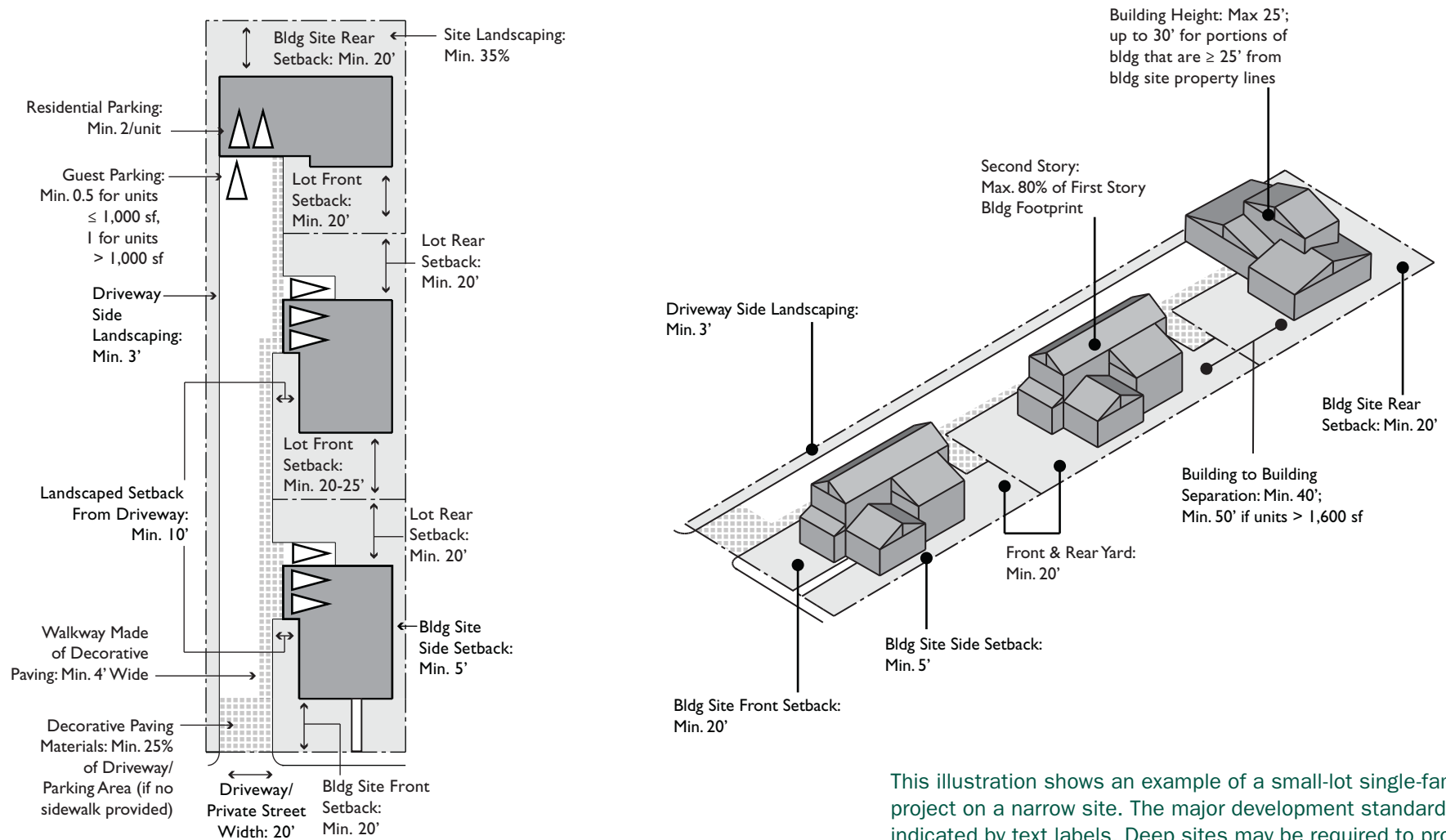

This illustration shows an example of a small-lot single-family project on a narrow site. The major development standards are indicated by text labels. Deep sites may be required to provide a fire turnaround per Fire Department standards.

Figure 2.3-3: Small-Lot Single-Family Homes: Narrow Lot (Lots < 60' Wide, Maximum Two Units): Summary of Major Development Standards

Note: Diagrams not to be used for density calculations.

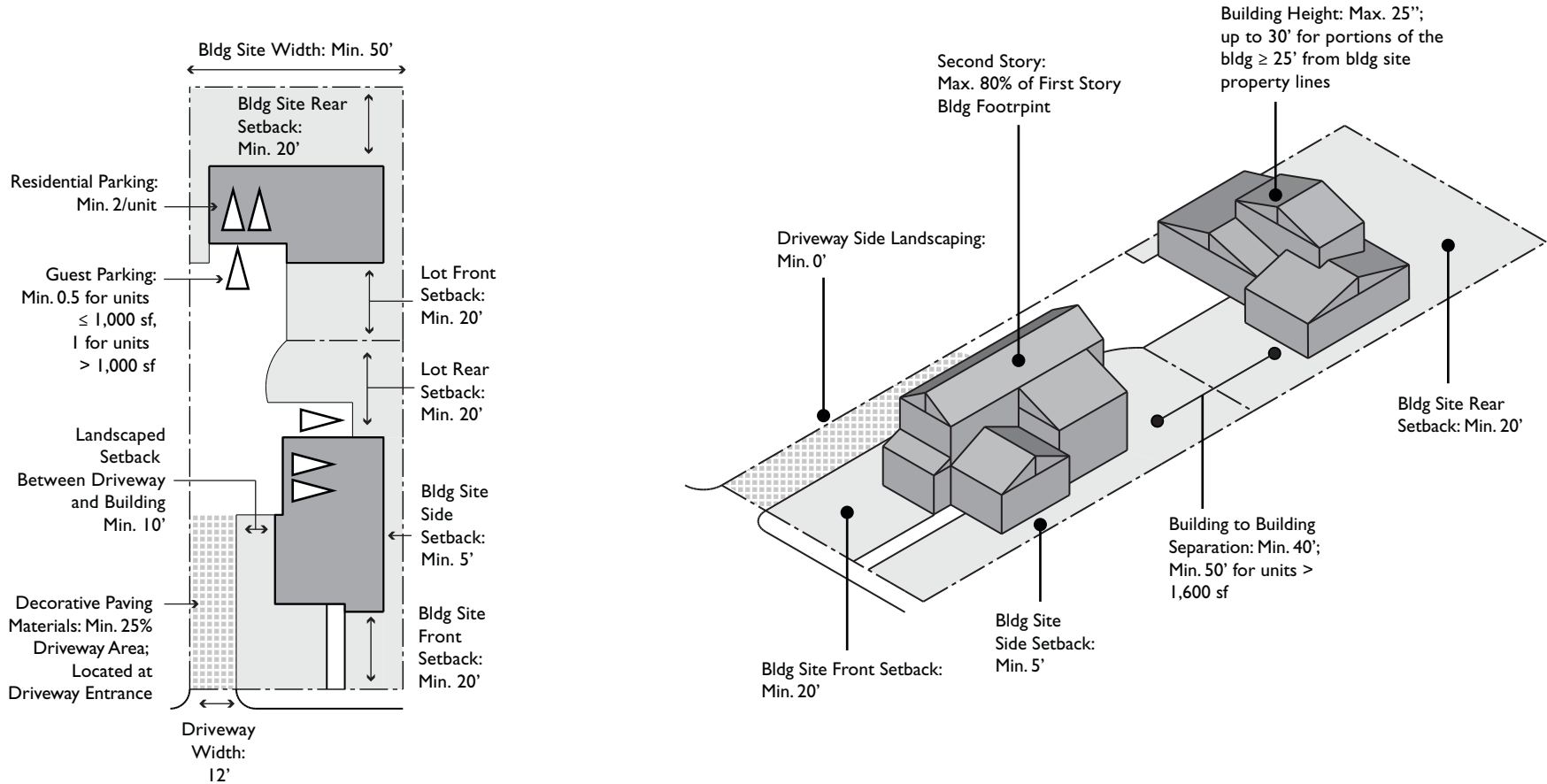

This illustration shows an example of a small-lot single-family project on a narrow site. The major development standards are indicated by text labels.

Figure 2.3-4: Small-Lot Single-Family: Height

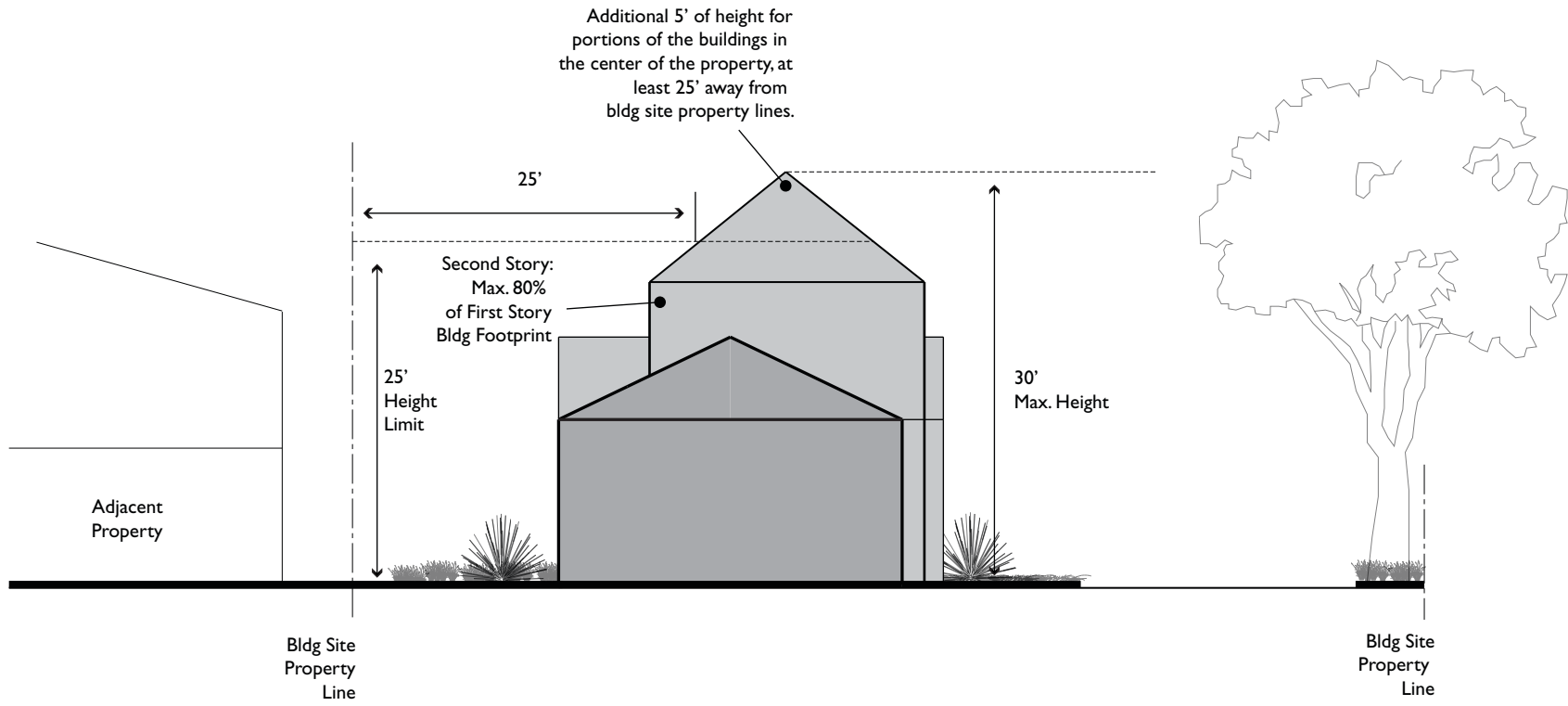

Figure 2.3-5: Small-Lot Single-Family: Front Yard Paving and Gates

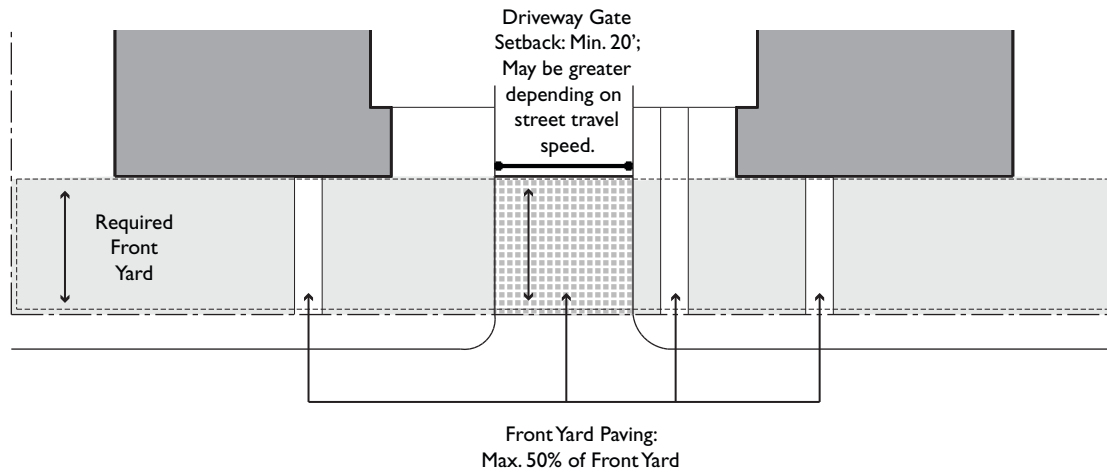

Figure 2.3-6: Small-Lot Single-Family: Front Porch or Covered Recess

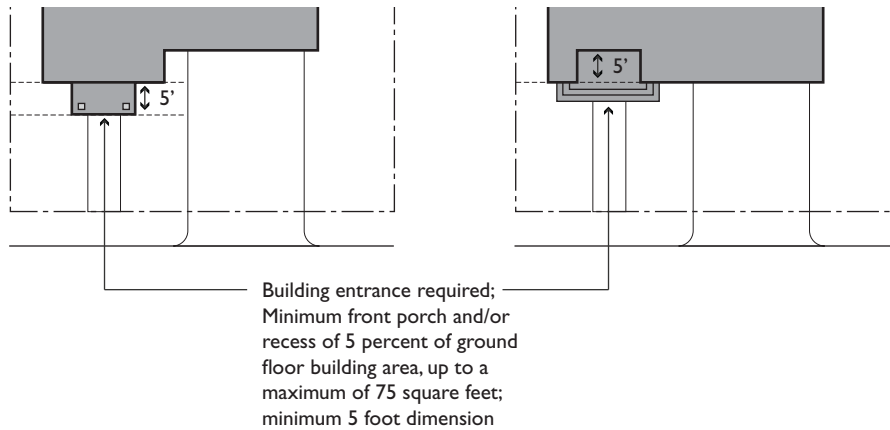

Figure 2.3-7: Small-Lot Single-Family: Interior Elevation

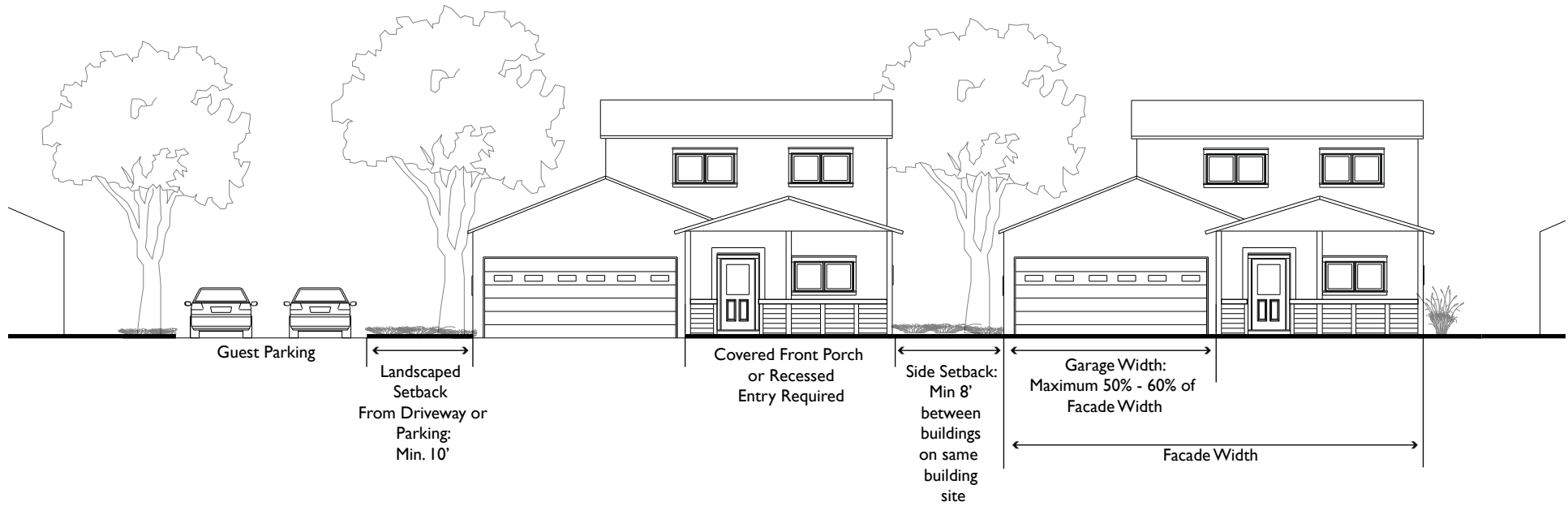

Figure 2.3-8: Small-Lot Single-Family: Garage Aprons

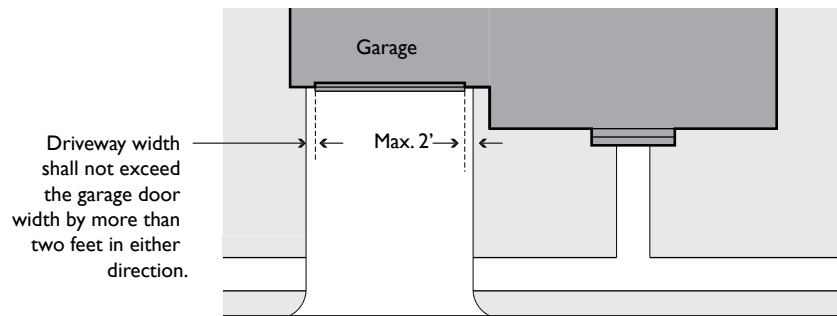
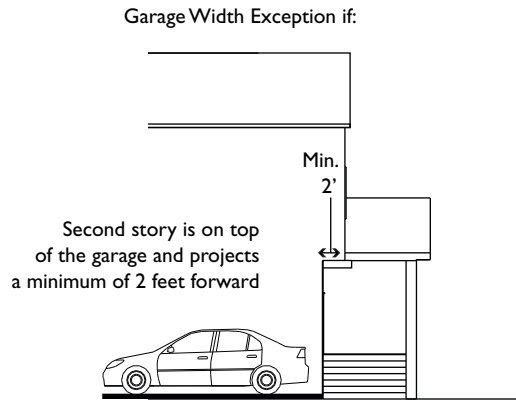

Figure 2.3-9: Small-Lot Single-Family: Garage Exception



or

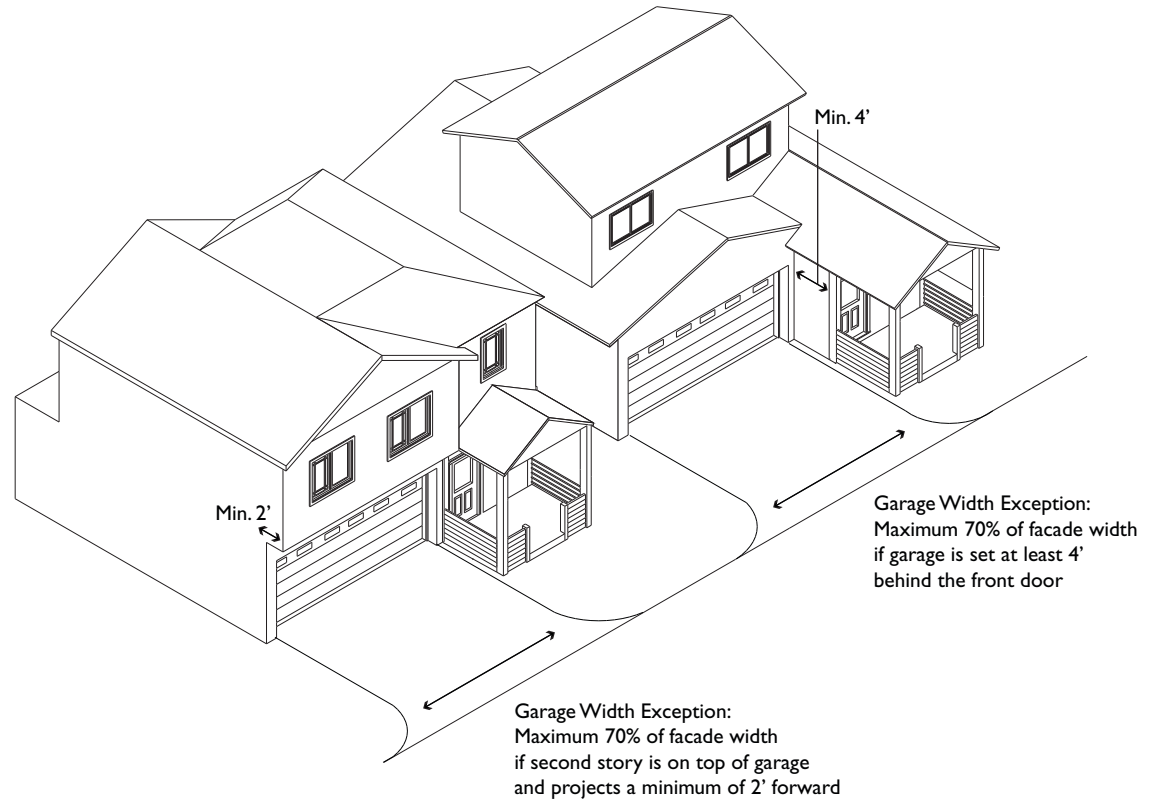
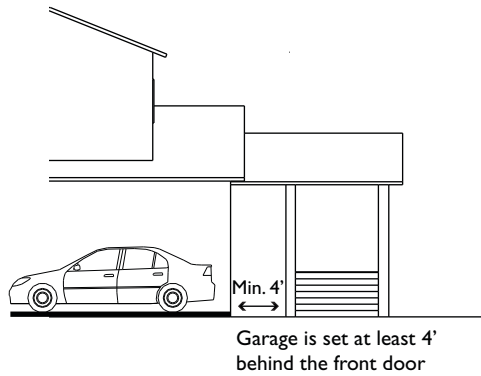



Figure 2.3-10: Small-Lot Single-Family: Side Setbacks

Building Site Width  $\geq$  80':  
Second story max. 80% of  
first story footprint; a minimum  
of 50% of the required bulk  
reduction shall occur along  
the building site  
side property line.

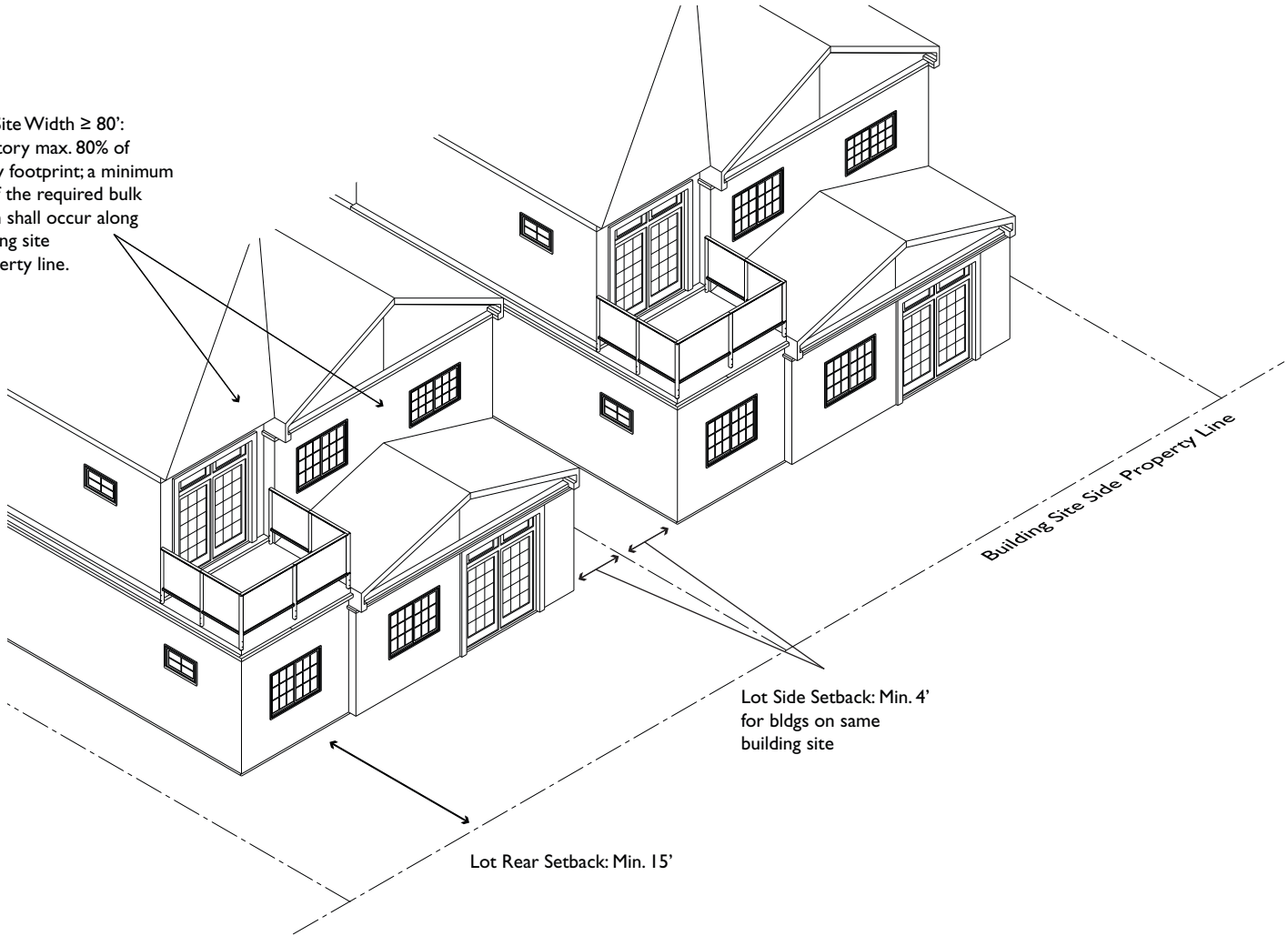
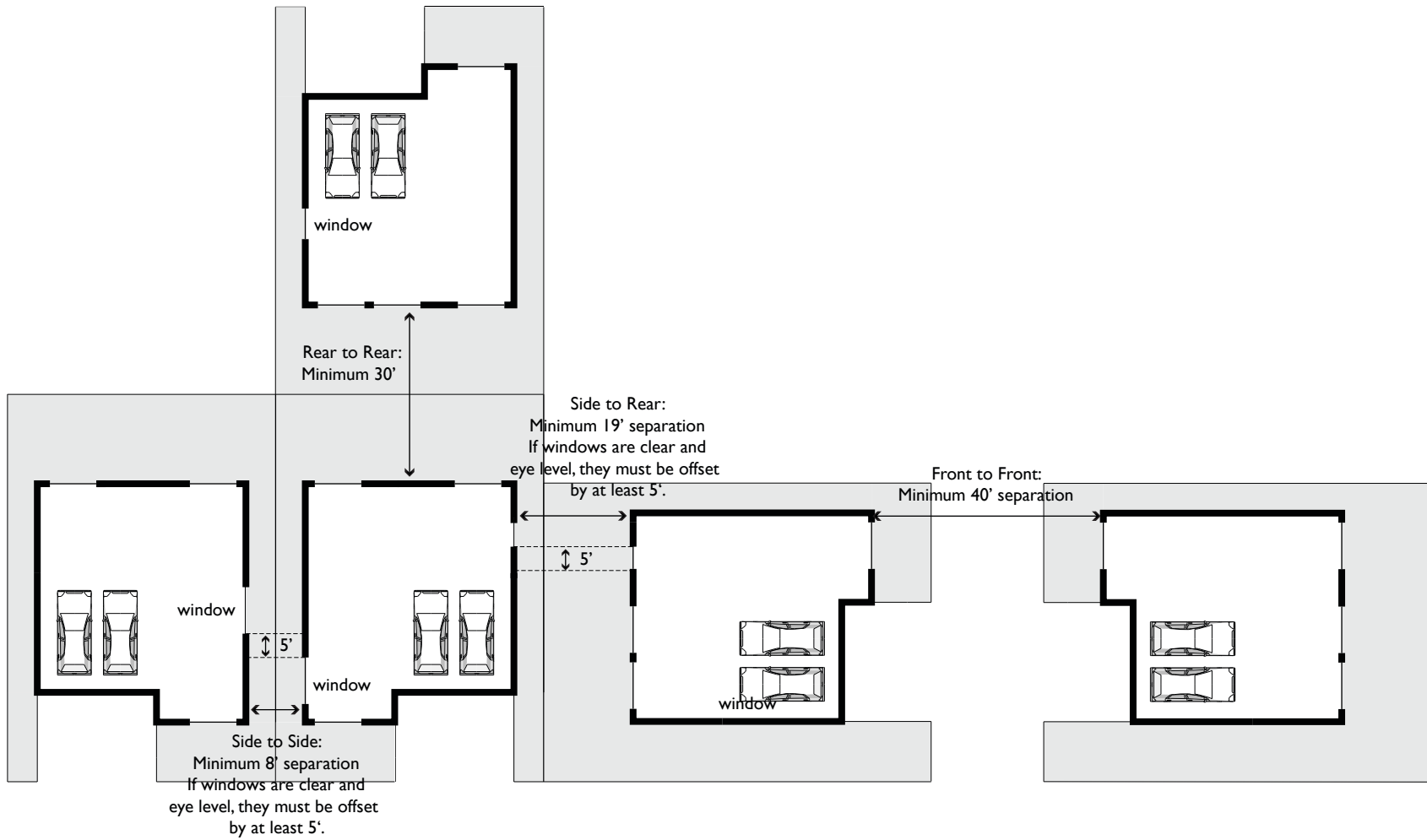

Figure 2.3-11: Small-Lot Single-Family: Minimum Distance Between Buildings



**TABLE 2.3-1: SMALL-LOT SINGLE FAMILY HOMES**

<b>Standard</b>	<b>R-S, R-S-D35, R-S-DV (with lot width &lt; 100' and lot area &lt; 20,000 sq ft)</b>	<b>Additional Standards</b>
<b>DEVELOPMENT INTENSITY AND NEIGHBORHOOD COMPATIBILITY</b>		
Minimum Building Site Size (sq ft)	5,000	
Minimum Area per Dwelling Unit (sq ft)		
R-S	5,000	If the width of a building site is less than 60 feet, the maximum number of small-lot single-family units allowed on the site is two and the minimum area per two small-lot single-family residential dwelling units is 7,500 square feet.
R-S-D35, R-S-DV	3,500	
Minimum Building Site Width (ft)	50	
Minimum Lot Width (ft)	40	
Minimum Lot Width Exception (ft)	30 - 35	A lot width of 35 feet may be necessary for small-lot single-family homes with attached double loaded garages in front and to comply with Parking Location and Design requirements. Lot width may be reduced to 30 feet if garages are single-car wide, detached and/or accessed from an alley.
<b>BUILDING HEIGHT AND FORM</b>		
Maximum Height (ft)	25	
Height Exception (ft)	30	Provided that the roof is pitched and the portion of the roof over 25 feet in height is at least 25 feet away from building site property lines. See Figure 2.3-4.
Maximum Stories	2	
Maximum Second Story Floor Area (%)	80	The second story floor area shall not exceed 80 percent of the first story building footprint area.
<b>BUILDING RELATIONSHIP TO THE STREET</b>		
Maximum Front Yard Paving (%)	50	See Figure 2.3-5.
Street Facing Façade Design	Required. Street facing facades must be designed to orient towards the public street, or private street if lot does not abut a public street. Windows, entry door, and other elements must be incorporated to create an attractive street appearance that is compatible with the surrounding neighborhood.	
Building Entrances on Streets	Required. The principal entry shall be located in a visible location facing the public street, or private street if lot does not abut public street.	
Covered Front Porch or Covered Recessed Entry	Required.	
Minimum Depth (ft)	5	Alternative designs that create a welcoming entry feature facing the street, such as a trellis or landscaped courtyard entry may be approved by Staff. See Figure 2.3-6.
Minimum Area of Porch and/or Recessed Entrance (sq ft)	5 percent of the first story building footprint area; up to a maximum of 75 square feet	

Table 2.3-1: Small-Lot Single-Family Homes

<b>Standard</b>	<b>R-S, R-S-D35, R-S-DV (with lot width &lt; 100' and lot area &lt; 20,000 sq ft)</b>	<b>Additional Standards</b>
<b>SETBACKS FOR LIGHT, AIR AND PRIVACY</b>		
Minimum Setbacks (ft)		Building site setbacks apply along the perimeter of a building site and lot setbacks apply to individual lots within a building site. In the event of conflict between building site setback requirements and lot setback requirements, the project must comply with whichever standard results in the greater setback.
Building Site		
Front (Facing Public Street)	20	Must be landscaped.
Side (Facing Adjacent Neighboring Properties)	5	A minimum of 50 percent of the required bulk reduction must occur along the building site side property line.  If a building is at or within 5 feet of this property line, a minimum of 50 percent of the second story facade shall be stepped back a minimum of 5 feet from the first story facade and a minimum of half of that required amount shall occur along this side setback.
Rear (Facing Adjacent Neighboring Properties)	20	
Lot (ft)		
Front	10	Must be landscaped.
Front Exception	20	If a building site width is less than 80 feet, the minimum front setback for a lot shall be 20 feet.
Side	8	Lot side yard setbacks are between buildings on the same building site.
Side Exception	Zero Lot Line	A zero lot line is permitted if the adjacent side yard is double the required amount. A zero lot line is not permitted next to adjacent neighboring property.
Rear	15	
Rear Exception	20	If a building site width is less than 80 feet, the minimum rear setback for a lot shall be 20 feet.
Minimum Distance Between Buildings (ft)		Front is considered any wall with windows into the primary living area of the unit. See Figure 2.3-10.
Front to Front or Rear	40	For building sites less than 80 feet in width, the minimum distance shall be 50 feet if units have a floor area of more than 1,600 square feet.
Rear to Rear	30	For building sites less than 80 feet in width, the minimum distance shall be 40 feet and the minimum distance shall be 50 feet if units have a floor area of more than 1,600 square feet.
Side to Front or Rear	19	If windows are clear and eye-level, they must be offset by at least 5 feet.
Side to Side	8	If windows are clear and eye level, they must be offset by at least 5 feet.
Minimum Setback From Access Driveway (ft)	10	Minimum Setback from Access Driveway for projects with 5 or more units is 10 feet and must be fully landscaped. Requires a walkway to each unit.  Minimum Setback from Access Driveway for projects with fewer than 5 units is 5 feet and must be fully landscaped. No walkway is required. If walkway is installed, it must be outside of required setback to driveway.
<b>2-36   RESIDENTIAL DEVELOPMENT PROJECTS</b>		

Table 2.3-1: Small-Lot Single-Family Homes

<b>Standard</b>	<b>R-S, R-S-D35, R-S-DV (with lot width &lt; 100' and lot area &lt; 20,000 sq ft)</b>	<b>Additional Standards</b>
Setback From Access Driveway Exception (ft)	7.5	The minimum setback from an access driveway for projects with 5 or more units shall be 7.5 feet when the building site width is less than or equals 60 feet. For projects with fewer than 5 units and a building site width is less than or equal to 60 feet, the minimum setback of the front unit from the access driveway is 5 feet. In both instances, the setback must be fully landscaped and any walkway, if installed, must be outside of that setback.
<b>AUTO CIRCULATION: SITE ACCESS AND DRIVEWAYS</b>		
Minimum Access Driveway/Private Street Width (ft)	20	
Minimum Access Driveway/Private Street Width Exception	12	Minimum 12 feet if lots are narrow and driveways serve fewer than 5 units. Fire Department may consider this exception if the rear-most corner of the rear-most building is within 150' of the curb and alternative means and methods are incorporated to meet Fire Code safety objectives.
Maximum Curb Cuts (number per building site)	1	Exception may be granted by Staff if building site exceeds one acre, building site frontage exceeds 200 feet, or through lot.
Minimum Driveway Gates Setback (ft)	20	Gates across driveways shall be set back a minimum of 20 feet behind the property line, or greater depending on location in State Responsibility Fire Area and street travel speed.
<b>PARKING LOCATION AND DESIGN</b>		
Maximum Garage Width (ft)	20	
Facing Public Street	Where garage doors face a public street, garage width shall not exceed 50 percent of the width of the front facade of the building.	
Facing Access Driveway/Private Street	Where garage doors face a private street or access driveway, garage width shall not exceed 60 percent of the width of the front facade of the building.	
Garage Width Exception	Where garage doors face a private street or access driveway, garage width shall not exceed 70 percent of the width of the front facade of the building if the garage (wall to wall) is set at least four feet behind the front door or a second story above the garage projects at least two feet forward in front of the garage. See Figure 2.3-9.	
Maximum Driveway Apron Width (ft)	Driveway apron widths shall not exceed the garage door width by more than one foot in either direction. See Figure 2.3-8	
Unit Parking (space per unit)	20	Minimum of one space must be covered. Tandem parking allowed for up to 25 percent of the units.
Guest Parking (space per unit)		Space along the public street frontage of a building site can be counted towards guest parking requirements. However, guest spaces may be required to be on the building site if there is existing parking congestion, as defined by the Planning Director, on the street. A parking study may be required to determine existing parking congestion. Driveway aprons may be counted for the required guest parking.
Units ≤ 1,000 sq ft	0.5	
Units > 1,000 sq ft	1	
<b>FACILITIES FOR PEDESTRIANS, BICYCLES, AND TRANSIT</b>		
Minimum Decorative Driveway Paving (% of Driveway and Parking Area)	10	Locate at driveway entrances, driveway aprons and in areas that can be used as open space.

Table 2.3-1: Small-Lot Single-Family Homes

<b>Standard</b>	<b>R-S, R-S-D35, R-S-DV (with lot width &lt; 100' and lot area &lt; 20,000 sq ft)</b>	<b>Additional Standards</b>
Minimum Decorative Driveway Paving Exception (%)	25	Required if there is no pedestrian walkway/sidewalk provided along the access driveway/private street. A minimum 4 foot wide walkway consisting of decorative paving shall also be provided. Walkway consisting of decorative paving is not required to be provided if there are two units on a building site.
Pedestrian Walkway Next to Access Driveway/Private Street	Required for 5 units or more	For fewer than 5 units, may have no sidewalk if driveway pavement has differentiated pedestrian paving.
Minimum Width of Pedestrian Walkway (ft)	4	
<b>SITE LANDSCAPING</b>		
Minimum Site Landscaping (%)	35	
Minimum Width of Landscaped Buffer Between Pedestrian Walkway and Access Driveway/Private Street (ft)	3	
Minimum Width of Side Landscaping for Driveway/Private Street/Parking Area (ft)	5	Applies between the driveway/private street/parking areas and the side and rear property lines.
Minimum Side Landscaping Exception (ft)	0 - 3	The minimum driveway side landscaping shall be 3 feet when building site width is less than 75 feet and greater or equal to 60 feet. The minimum driveway side landscaping shall be 0 feet when the building site width is less than 60 feet. Staff may approve a minimum side landscaping of 3 feet for building sites that are 75 feet or wider if vertical landscaping (e.g. trees, shrubs, bushes) is planted along this side landscaping area.
<b>USABLE OPEN SPACE</b>		
Minimum Total Usable Open Space (sq ft per unit)	600	Common usable open space is not required for projects with four units or fewer, provided that each small-lot single-family unit has a minimum of 500 square feet of private open space.
Minimum Common Usable Open Space (sq ft)	1,000 square feet; no less than 200 square feet per unit	Common space buildings or covered structures cannot occupy more than 20 percent of common open space.
Minimum Dimension (ft)	25	
Minimum Private Usable Open Space (sq ft per unit)	500	Private open space must be open air, not fully enclosed with walls. Private open space cannot be covered by a roof by more than 50 percent of the area; however balconies can have up to 100 percent ceiling coverage.

## 2.4 Townhome Standards

This section presents the development standards for townhomes. The purpose of the townhome standards is to allow for a variety of housing types in the unincorporated areas of Alameda County while also achieving neighborhood goals for an attractive street appearance. The standards are also to ensure that basic needs for sunlight, privacy, ventilation, recreation area and parking are provided.

Townhomes are two or three story attached units, with an individual entry on the ground floor and a private yard area. Attached garages are characteristic of this building type, but parking may also be in the form of detached garages or parking courts. Townhome projects may be structured as fee-simple lots or as a condominium subdivision; they may also be rental units.

Two-story townhomes require a minimum building site of 2,500 to 3,500 square feet per dwelling unit while three-story townhomes require a minimum 2,000 to 2,500 square feet per dwelling unit. Three-story townhomes are appropriate on larger building sites (sites that are 20,000 square feet or more and with a minimum width of 100 feet) so the extra height can be away from property lines.

These standards apply to townhomes, which are appropriate in the R-S-D35, R-S-D25, R-2, R-S-D3, R-S-D20, R-S-DV, and R-3 Zoning Districts. These districts are predominantly located in Cherryland, Ashland and Hayward Acres.



Figure 2.4-1: Two-Story Townhomes: Summary of Major Development Standards

Note: Diagrams not to be used for density calculations.

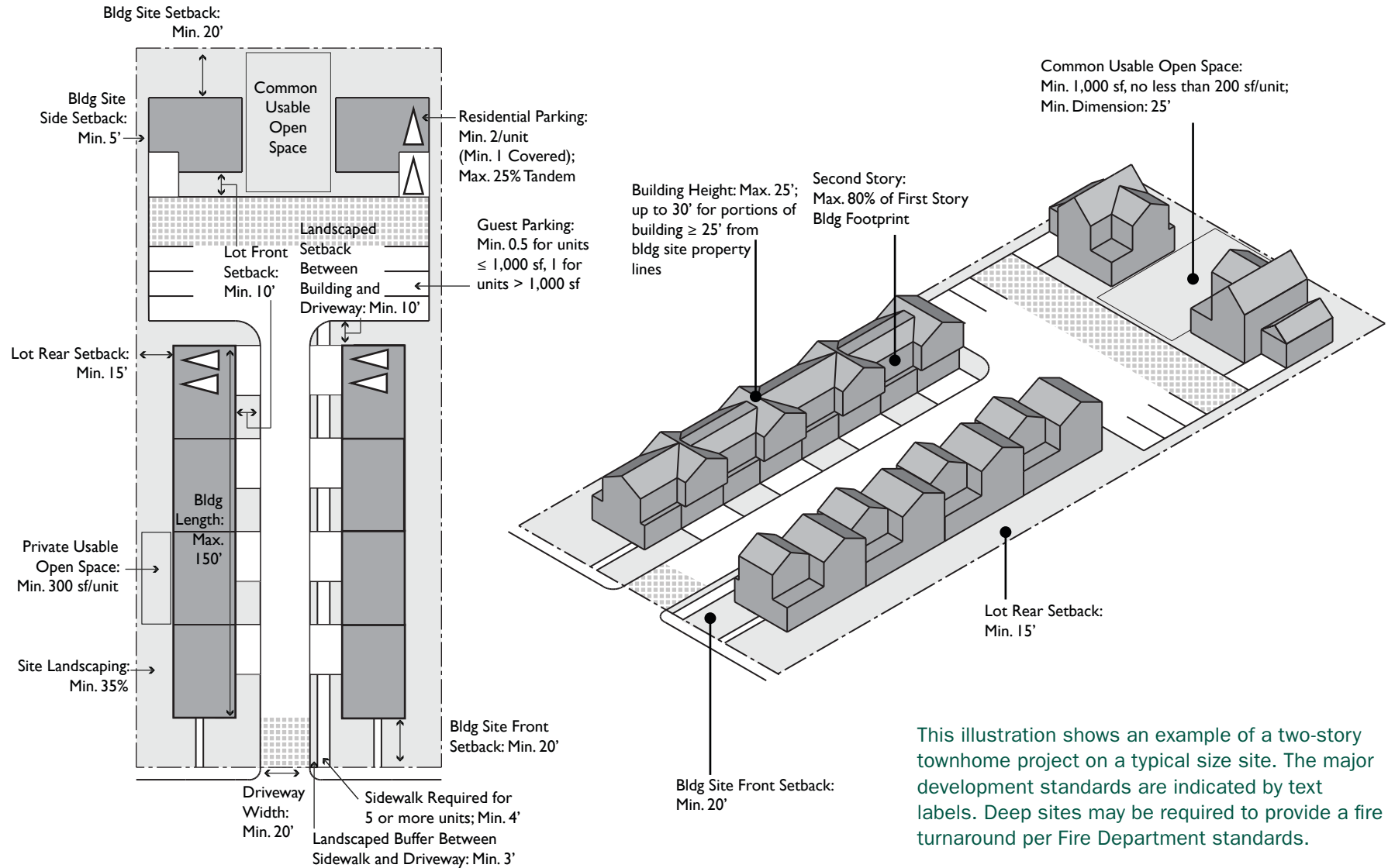
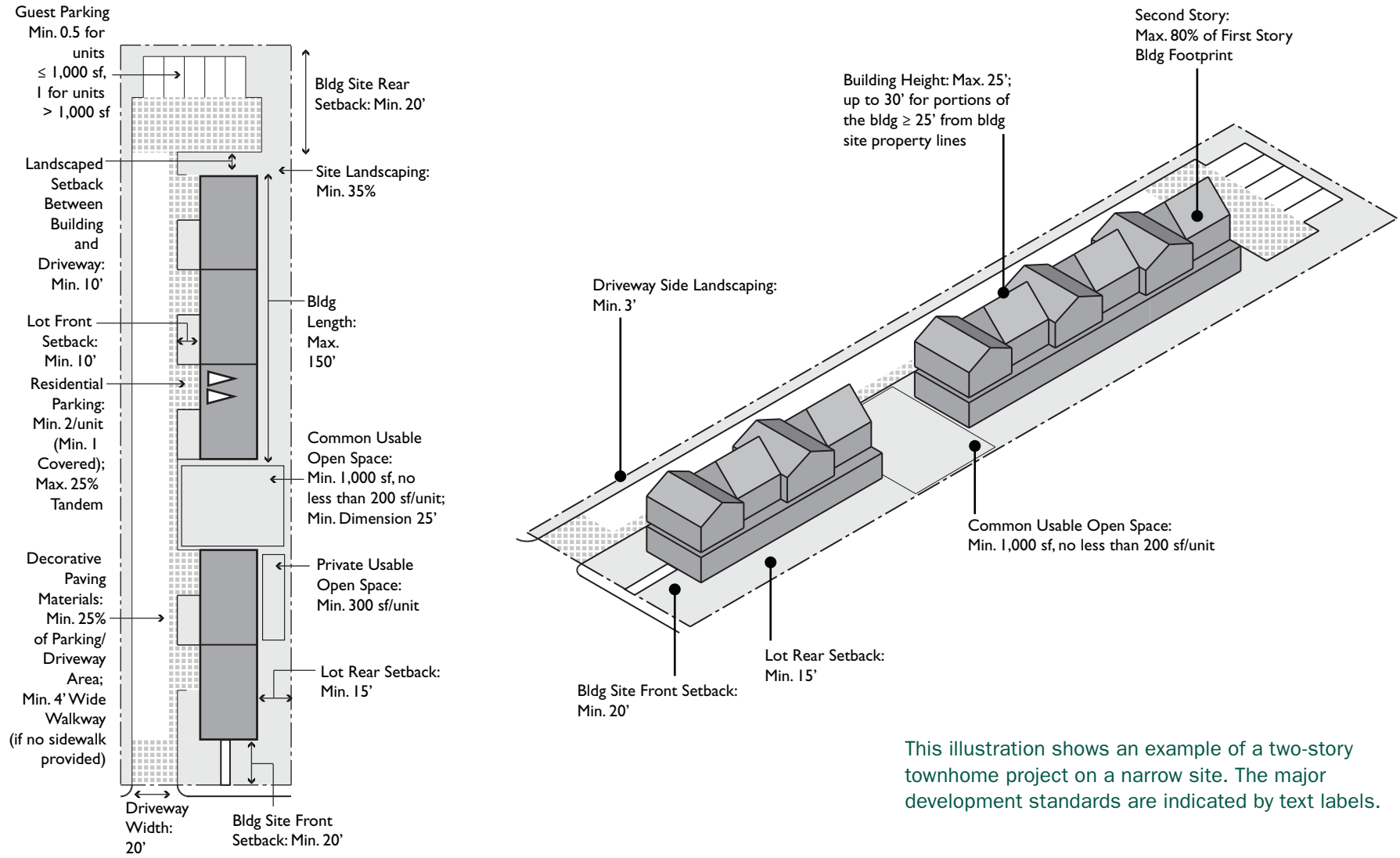



Figure 2.4-2: Townhomes on Narrow Lots: Summary of Major Development Standards

Note: Diagrams not to be used for density calculations.



This illustration shows an example of a two-story townhome project on a narrow site. The major development standards are indicated by text labels.

Figure 2.4-3: Three-Story Townhomes: Summary of Major Development Standards

Note: Diagrams not to be used for density calculations.

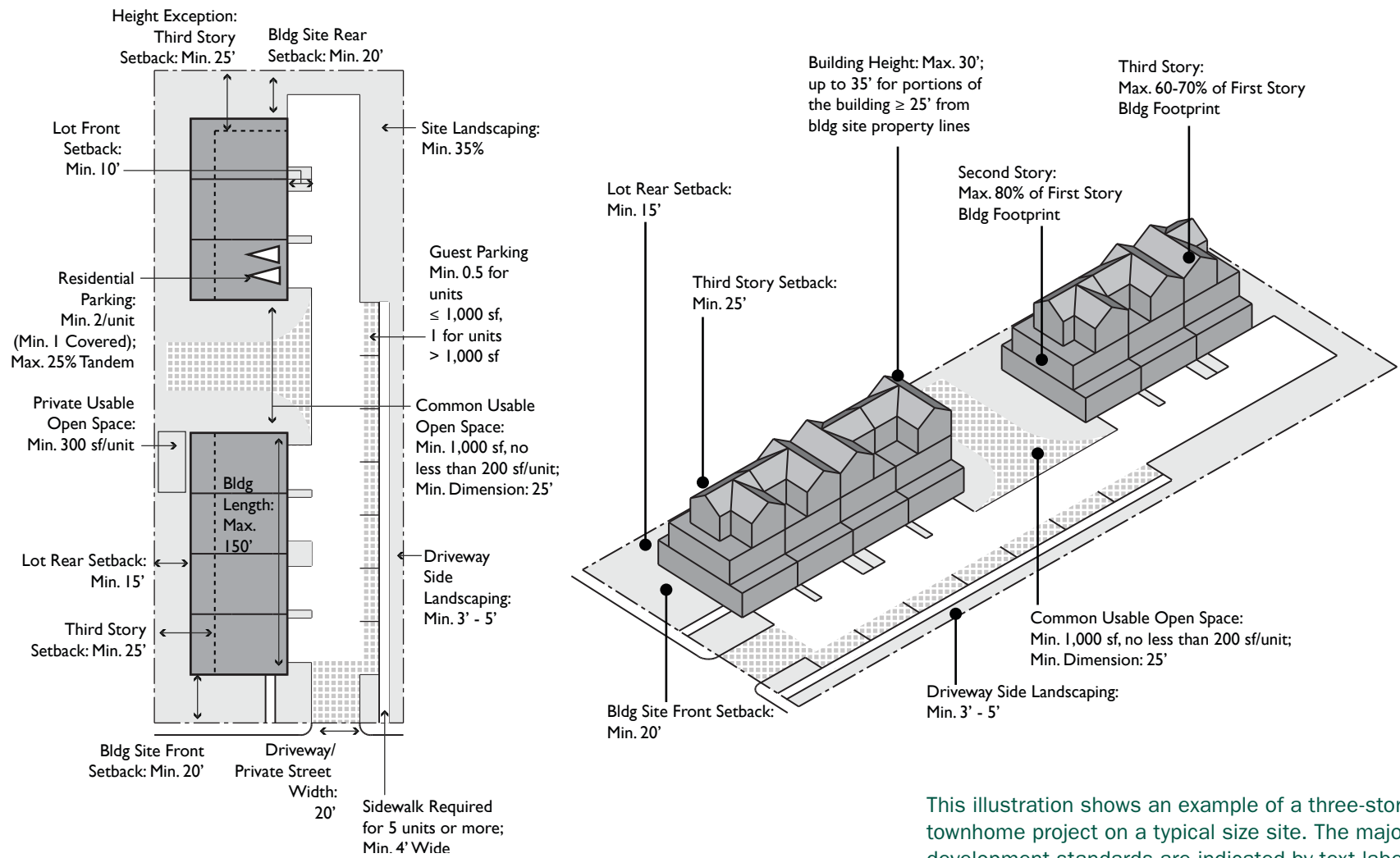

This illustration shows an example of a three-story townhome project on a typical size site. The major development standards are indicated by text labels. Deep sites may be required to provide a fire turnaround per Fire Department standards.

Figure 2.4-4: Townhomes: Height

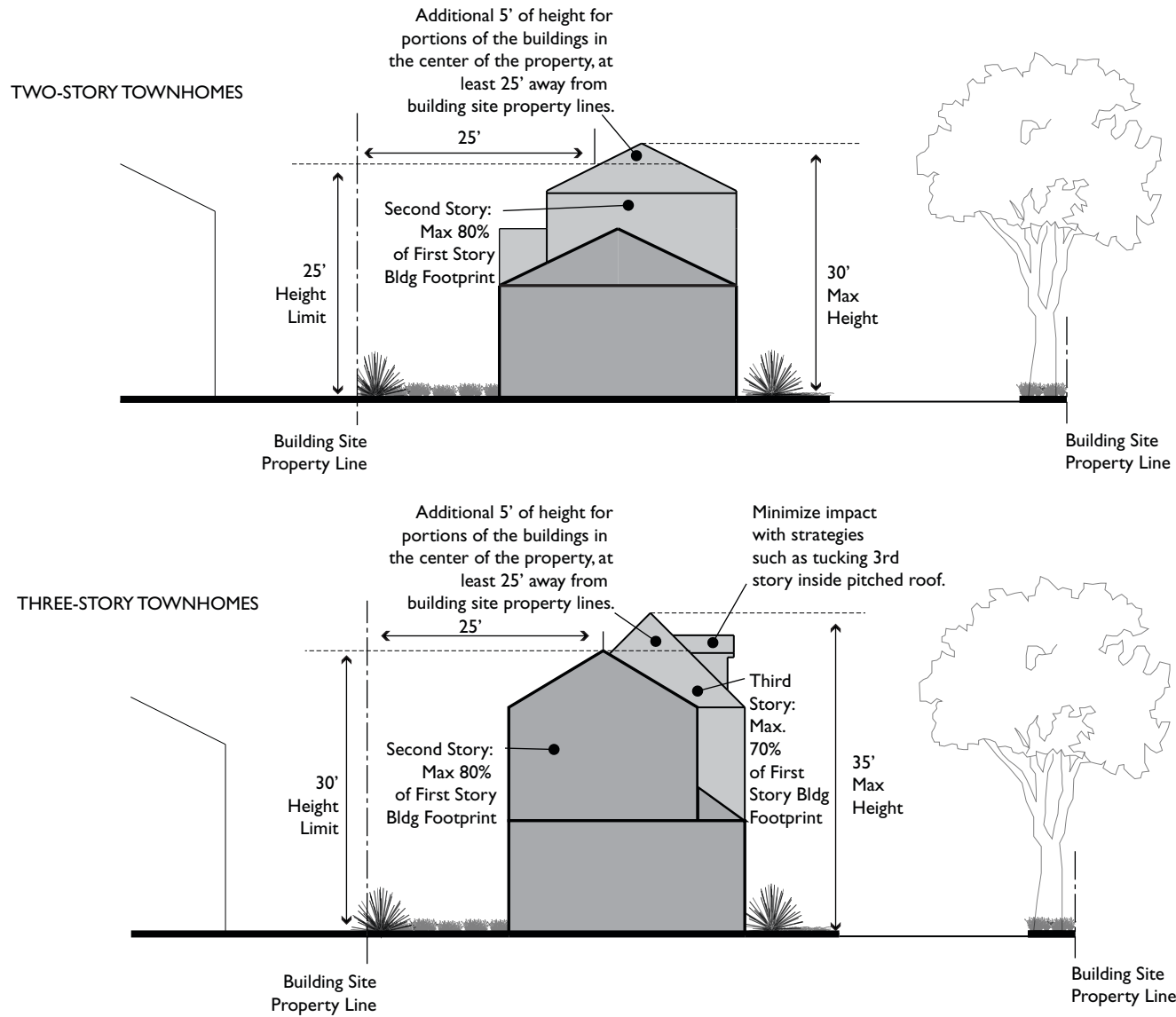

Figure 2.4-5: Townhomes: Garage Width

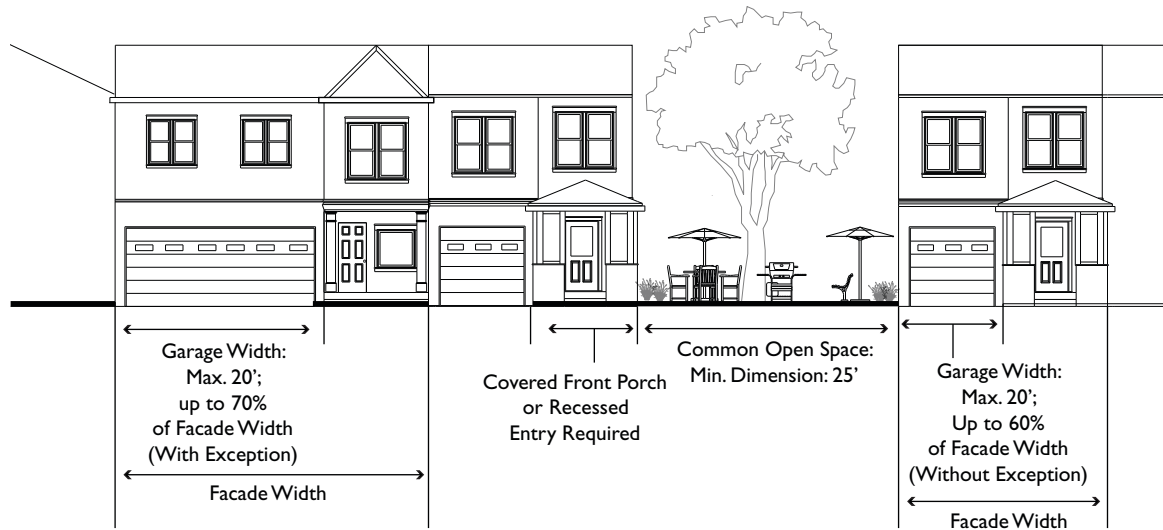

Figure 2.4-6: Townhomes: Garage Width Exception

Garage Width Exception:

Two-Story Townhomes:  
Maximum 70% of Facade Width

IF:

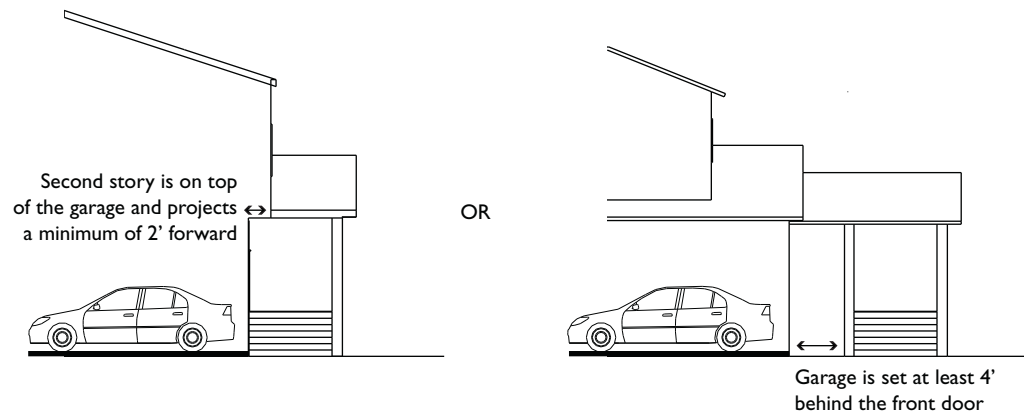

Figure 2.4-7: Townhome: Garage Width Exception for Three Stories



Garage Width Exception:

Three-Story Townhomes:  
Maximum 80% of Facade Width

IF:

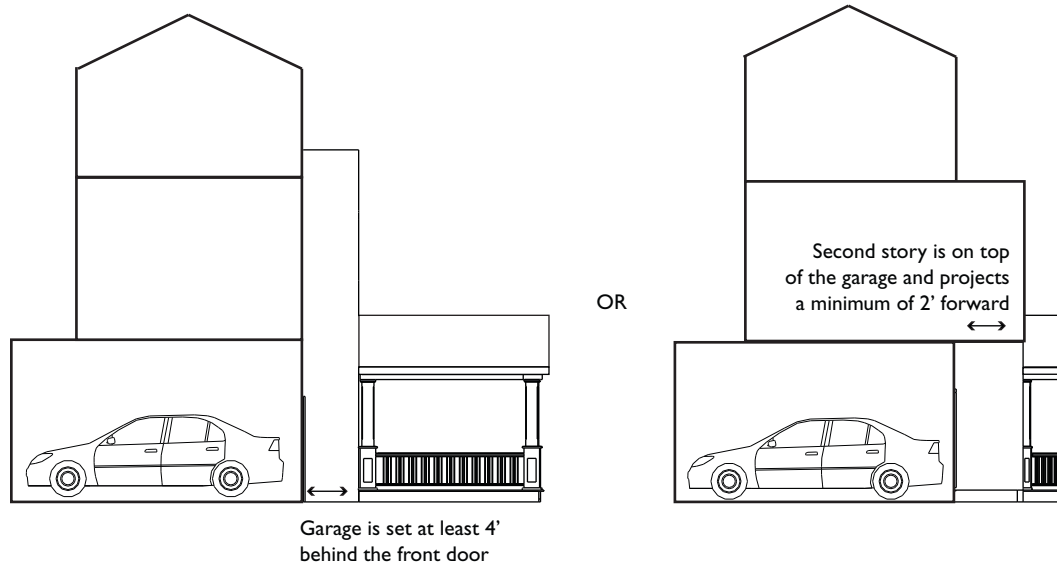

Figure 2.4-8: Townhomes: Side Yards



Figure 2.4-9: Townhomes: Open Space

Private Usable Open Space:  
Min. 100 sf/unit

Balcony Dimension: Min. 7'

Ground Floor Dimension: Min. 10'

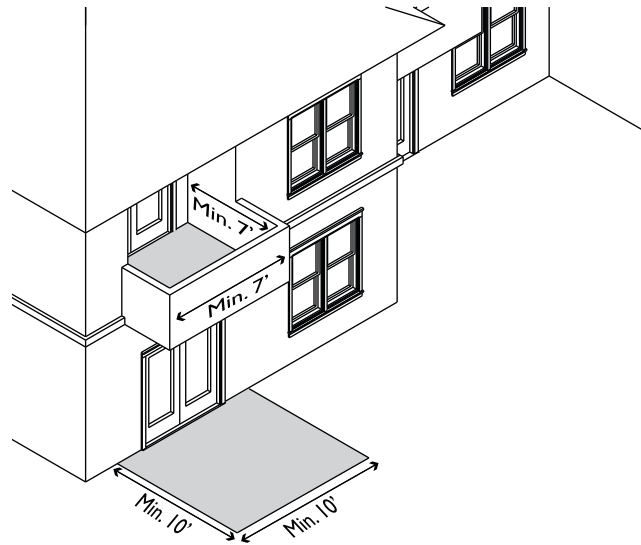

Figure 2.4-10: Townhomes: Front Yard Paving and Gates

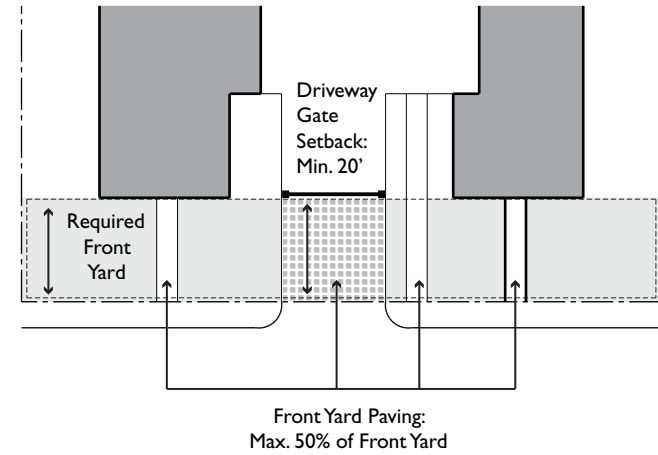

Figure 2.4-11: Townhomes: Front Porch or Covered Recess

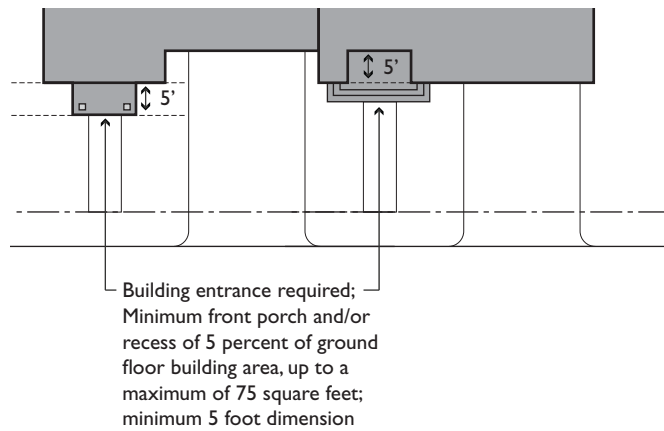
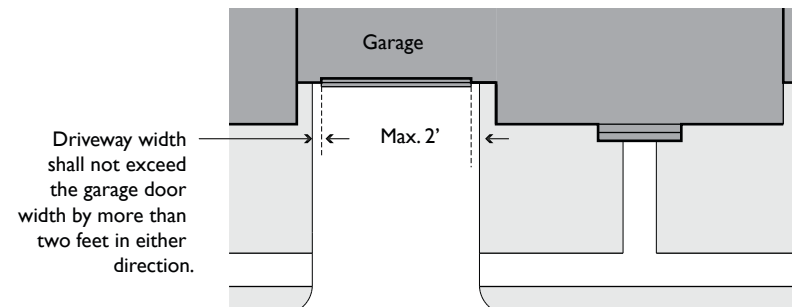

Figure 2.4-12: Townhomes: Driveway Aprons



*Page Intentionally Left Blank*



**TABLE 2.4-1: TOWNHOME STANDARDS**

<b>Standard</b>	<b>R-S-D35, R-S-DV, R-S-D25, R-2, R-S-D20, R-3, R-S-D3</b>	<b>Additional Standards</b>
<b>DEVELOPMENT INTENSITY AND NEIGHBORHOOD COMPATIBILITY</b>		
Minimum Building Site Size (sq ft)	5,000	
Minimum Area per Dwelling Unit (sq ft)		
R-S-D35, R-S-DV (with lot width < 100' and lot area < 20,000 sq ft)	3,500	Appropriate for two-story townhomes.
R-S-D3	3,000 - 2,000	Appropriate for two-story townhomes. Appropriate for three-story townhomes at minimum 2,000 square feet. Density is as specified in the zoning amendment creating the district.
R-S-D25, R-2	2,500	Appropriate for two-story or three-story townhomes.
R-S-D20, R-3, R-S-DV (with lot width ≥ 100' and lot area ≥ 20,000 sq ft)	2,000	Appropriate for three-story townhomes.
Minimum Building Site Width (ft)		
Two-Story Townhomes	65	
Three-Story Townhomes	75	
Minimum Lot Width (ft)	25	A minimum lot width of 30 to 40 feet may be necessary for two-story townhomes with double loaded attached garages in front, and to comply with Parking Location and Design requirements. Minimum lot width may be reduced to 20 feet if garages are single-car wide, detached and/or accessed from an alley.
<b>BUILDING HEIGHT AND FORM</b>		
Maximum Height (ft)		See Figure 2.4-4.
Two-Story Townhomes	25	
Two-Story Exception	30	Provided that roof is pitched and the portion of the roof over 25 feet in height is at least 25 feet away from building site property lines.
Three-Story Townhomes	30	

Table 2.4-1: Townhome Standards

<b>Standard</b>	<b>R-S-D35, R-S-DV, R-S-D25, R-2, R-S-D20, R-3, R-S-D3</b>	<b>Additional Standards</b>
Three-Story Exception	35	Provided that roof is pitched and the portion of the roof over 30 feet in height is at least 25 feet away from building site property lines.
Maximum Stories	2 - 3	
Maximum Floor Area (Percentage of First Story Building Footprint)		
Second Story (%)	80	The second story shall not exceed 80 percent of the first story building footprint area.
Third Story (%)	70	The third story shall not exceed 70 percent of the first story building footprint area.
Maximum Building Length (ft)	150	Exceptions may be approved by Staff if buildings are designed with many different setbacks (instead of a long flat wall), changes in roof form or height, and major recesses (notches) along the length of the building, which successfully break up the massing of the building.
<b>BUILDING RELATIONSHIP TO THE STREET</b>		
Maximum Front Yard Paving (%)	50	
Street Facing Façade Design	Required. Street facing facades must be designed to orient towards the public street, or private street if lot does not abut a public street. Windows, entry door, and other elements must be incorporated to create an attractive street appearance that is compatible with the surrounding neighborhood.	
Building Entrances on Streets	Required. The principal entry shall be located in a visible location facing the public street, or private street if lot does not abut a public street.	
Covered Front Porch or Covered Recessed Entry	Required	
Minimum Depth (ft)	5	Alternative designs that create a welcoming entry feature facing the street, such as a trellis or landscaped courtyard entry may be approved by Staff. See Figure 2.4-11.
Minimum Area of Porch or Recessed Area (sq ft)	5 percent of the first story building footprint area; up to a maximum of 75 square feet	
<b>SETBACKS FOR LIGHT, AIR, AND PRIVACY</b>		
Minimum Setbacks (ft)		Building setbacks apply along the perimeter of a building site and lot setbacks apply to individual lots within a building site. In the event of conflict between building setback requirements and lot setback requirements, the project must comply with whichever standard results in the greater setback.

Table 2.4-1: Townhome Standards

<b>Standard</b>	<b>R-S-D35, R-S-DV, R-S-D25, R-2, R-S-D20, R-3, R-S-D3</b>	<b>Additional Standards</b>
Building Site		
Front (Facing Public Street)	20	
Side (Facing Adjacent Neighboring Properties)	5	A minimum of 50 percent of the required bulk reduction shall occur along the building site side property line. If a building is within 5 feet of this property line, a minimum of 50 percent of the second story facade shall be stepped back a minimum of 5 feet from the first story facade and a minimum of half of that required amount shall occur along this side setback.
Side Exception	10	The building site side setback shall be a minimum of 10 feet if the project consists of three-story townhomes.
Rear (Facing Adjacent Neighboring Properties)	20	
Lot		
Front	10	
Side	5	Required setbacks apply to the ends of rows of attached single-unit dwellings.
Rear	15	
Minimum Distance Between Buildings (ft)		
Front to Front or Rear	40	Front is considered any wall with windows into the primary living area of the unit.
Rear to Rear	30	
Side to Front or Rear	20	If windows are clear and eye-level, they must be offset by at least 5 feet.
Side to Side	10	If windows are clear and eye level, they must be offset by at least 5 feet.
Minimum Setback From Access Driveway (ft)		
Setback From Access Driveway Exception (ft)	7.5	The minimum setback from access driveway shall be 7.5 feet if building site width is less than 70 feet and greater than or equal to 6 feet; Must be landscaped.

Table 2.4-1: Townhome Standards

<b>Standard</b>	<b>R-S-D35, R-S-DV, R-S-D25, R-2, R-S-D20, R-3, R-S-D3</b>	<b>Additional Standards</b>	
<b>AUTO CIRCULATION: SITE ACCESS AND DRIVEWAYS</b>			
Minimum Access Driveway/Private Street Width (ft)	20		
Minimum Access Driveway/Private Street Width Exception	12	Minimum 12' if lots are narrow and driveways serve fewer than 5 units. Fire Department may consider this exception if the rear-most corner of the rear-most building is within 150' of the curb and alternative means and methods are incorporated to meet Fire Code safety objectives.	
Maximum Curb Cuts (number per building site)	1	Exception may be granted by Staff if building site exceeds one acre, building site frontage exceeds 200 feet, or through lot.	
Minimum Driveway Gates Setback (ft)	20	Gates across driveways shall be set back a minimum of 20 feet behind the property line, or greater depending on location in State Responsibility Fire Area and street travel speed.	
<b>PARKING LOCATION AND DESIGN</b>			
Maximum Garage Width (ft)	20		
Facing Public Street (%)	Where garage doors face a public street, garage width shall not exceed 50 percent of the width of the front facade of the building unit.		
Facing Access Driveway/Private Street (%)	Where garage doors face a private street or access driveway, garage width for two-story townhomes shall not exceed 60 percent and three-story townhomes shall not exceed 70 percent of the width of the front facade of the building unit.		
Facing Access Driveway/Private Street Exception (%)	Where garage doors face a private street or access driveway, garage width for two-story townhomes shall not exceed 70 percent and three-story townhomes shall not exceed 80 percent of the width of the front facade of the building if the garage (wall to wall) is set at least four feet behind the front door or a second story above the garage projects at least two feet forward in front of the garage.		
Maximum Driveway Apron Width (ft)	Driveway apron widths shall not exceed the garage door width by more than one foot in either direction. See Figure 2.4-12.		
Unit Parking (space per unit)	2	Minimum of one space must be covered. Tandem parking allowed for up to 25 percent of the units.	
Guest Parking (space per unit)	Space along the public street frontage of a building site can be counted towards guest parking requirements. However, guest spaces may be required to be on the building site if there is existing parking congestion, as defined by the Planning Director, on the street. A parking study may be required to determine existing parking congestion. Driveway aprons may be counted for the required guest parking.		
Units ≤ 1,000 sq ft			0.5
Units > 1,000 sq ft			1

Table 2.4-1: Townhome Standards

<b>Standard</b>	<b>R-S-D35, R-S-DV, R-S-D25, R-2, R-S-D20, R-3, R-S-D3</b>	<b>Additional Standards</b>
<b>FACILITIES FOR PEDESTRIANS, BICYCLES, AND TRANSIT</b>		
Minimum Decorative Driveway Paving (% of Driveway and Parking Area)	10	Locate at driveway entrance, driveway aprons and in areas that can be used as open space.
Minimum Decorative Driveway Paving Exception (% of Driveway and Parking Area)	25	Required if there is no pedestrian walkway/sidewalk provided along the access driveway/private street. A minimum 4 foot wide walkway consisting of decorative paving should also be provided.
Pedestrian Walkway Next to Driveway/Private Street	Required for 5 units or more.	Staff may approve exception for building sites with width less than 80 feet, provided that the percentage of minimum decorative driveway paving exception is met.
Minimum Width of Pedestrian Walkway (ft)	4	
<b>SITE LANDSCAPING</b>		
Minimum Site Landscaping (%)	35	
Minimum Width of Landscaped Buffer between Pedestrian Walkway and Access Driveway/Private Street (ft)	3	
Minimum Width of Landscaping for Driveway/Private Street/Parking Area (ft)	5	Applies between the access driveway/private street/parking areas and the side and rear property lines.
Minimum Side Landscaping Exception (ft)	3	The minimum width of driveway side landscaping shall be 3 feet when building site width is less than 75 feet.
<b>USABLE OPEN SPACE</b>		
Minimum Total Usable Open Space (sq ft per unit)	600	Common usable open space is not required for projects with four units or fewer provided that each townhome unit has a minimum of 300 square feet of private open space.
Minimum Common Usable Open Space (sq ft)	1,000 square feet; no less than 200 square feet per unit	Common open space buildings or covered structures cannot occupy more than 20 percent of common open space.
Minimum Dimension (ft)	25	
Minimum Private Usable Open Space (sq ft)	300	Private open space must be open air, not fully enclosed with walls. Private open space cannot be covered by a roof by more than 50 percent of the area; however balconies can have up to 100 percent ceiling coverage.
Minimum Ground Floor Dimension (ft)	10	See Figure 2.4-9.
Minimum Balcony Dimension (ft)	7	

*Page Intentionally Left Blank*

## 2.5 Multi-Family Residential Standards

This section presents the development standards for multi-family residential projects, including both apartments and condominiums.

The purpose of the multi-family residential standards is to allow for a variety of housing types in the unincorporated areas of Alameda County that serve all types of households, while also achieving neighborhood goals for an attractive street appearance, and minimizing impacts on neighboring properties. The standards are also to ensure a quality living environment that will be desirable and hold its value over time. When apartment and condominium projects are well designed, they can provide good quality housing and be a great contributor to neighborhoods.

Multi-family residential development is a multi-story building which has a shared entry lobby, and common access areas such as hallways or stairways that lead to individual units. Parking is often shared, whether in a garage or parking court.

Medium density multi-family residential development requires a minimum of 1,500 to 2,500 square feet per dwelling unit. High density multi-family residential development requires a minimum of 1,250 to 1,000 square feet per dwelling unit. Densities may be higher in some areas of the Castro Valley Central Business District and the Ashland Cherryland Business District if certain standards are met.

Medium density multi-family residential development is appropriate in the R-S-D20, R-3, R-S-DV, R-S-D15, and R-S-D3 zones, which are located in parts of Ashland and Castro Valley, and for larger projects sites in Hayward Acres and south Cherryland. Medium density multi-family residential is appropriate in Subareas 4, 5, 6, 7 and 11 in the Castro Valley Central Business District Specific Plan area, with some limitations. (See Table 2.1-1) It is also appropriate in the Residential Commercial (R/C) designation in the Ashland Cherryland Specific Plan area, along Lewelling Boulevard.

High density multi-family residential development is appropriate in the R-4 zone, a limited zoning designation in Ashland and Cherryland. It is also appropriate in Subareas 8 and 9 in the Castro Valley Central Business District Specific Plan Area, with some limitations. (See Table 2.1-1)



**Figure 2.5-1: Multi-Family Residential: Summary of Major Development Standards**  
 For illustrative purposes only; see Table 2.5-1 for details.

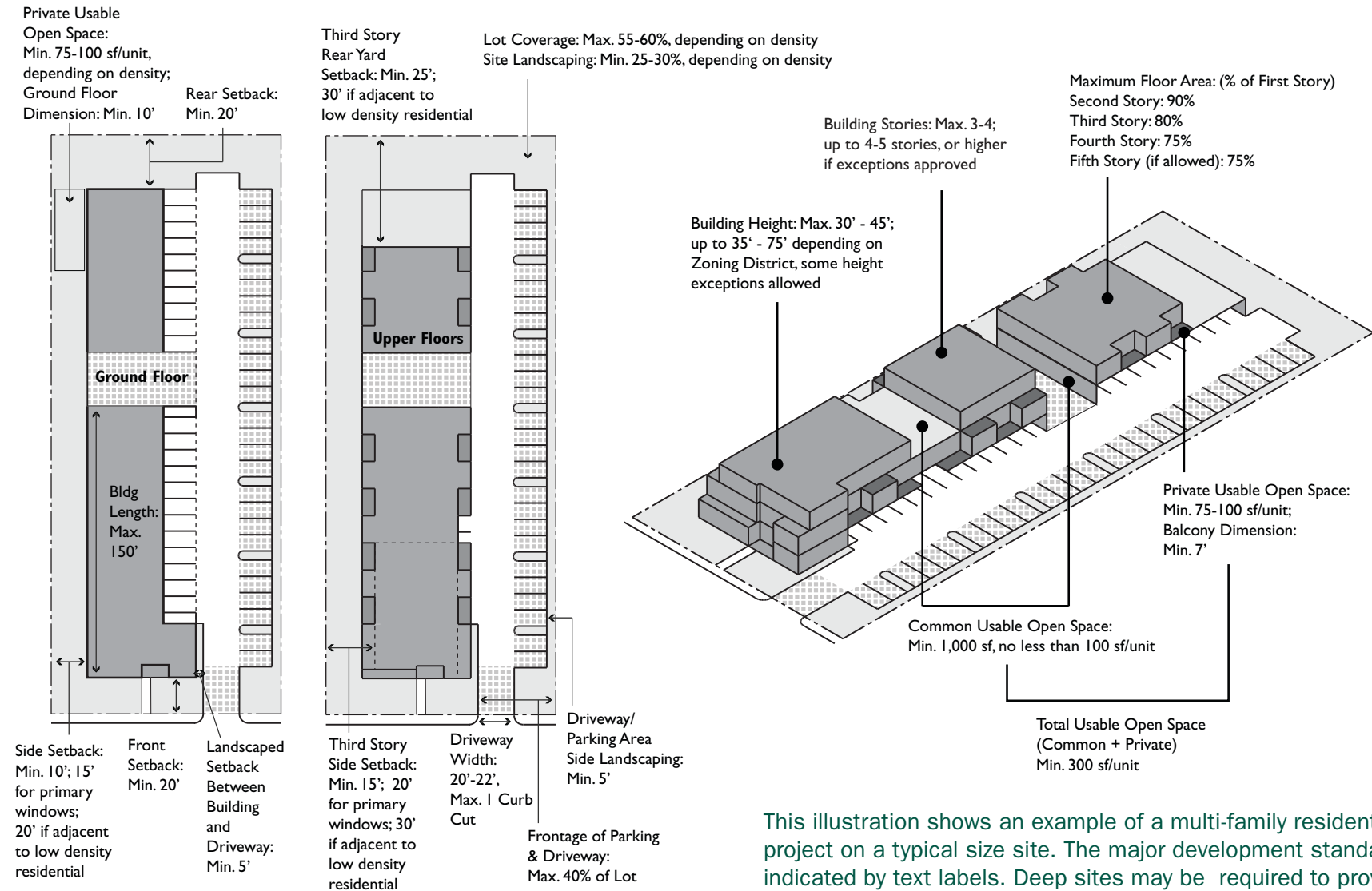

This illustration shows an example of a multi-family residential project on a typical size site. The major development standards are indicated by text labels. Deep sites may be required to provide a fire turnaround per Fire Department standards.



Figure 2.5-2: Multi-Family Residential Project  
For illustrative purposes only; see Table 2.5-1 for details.

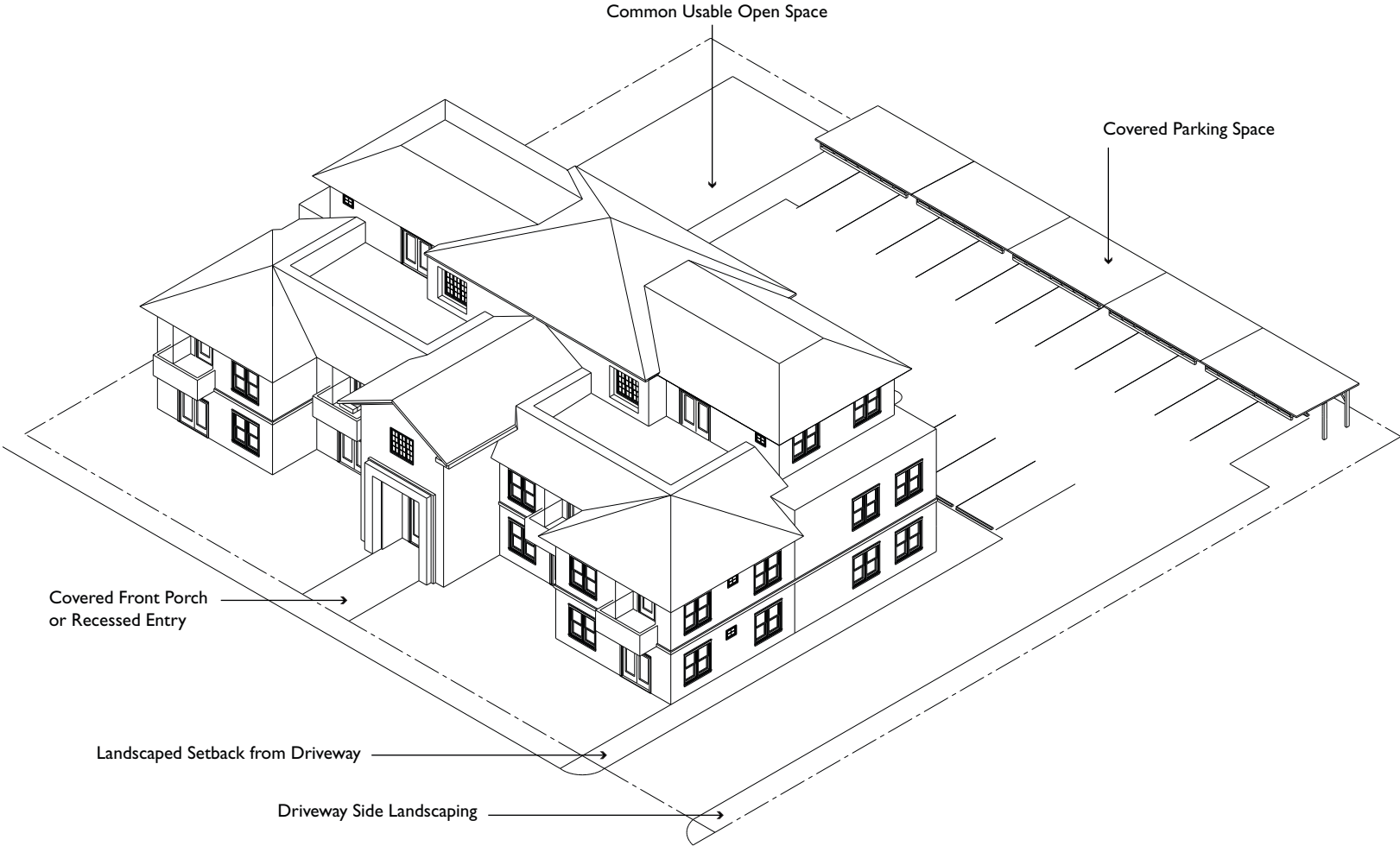

Figure 2.5-3: Multi-Family Residential: Elevation



Figure 2.5-4: Multi-Family Residential: Front Yard Paving

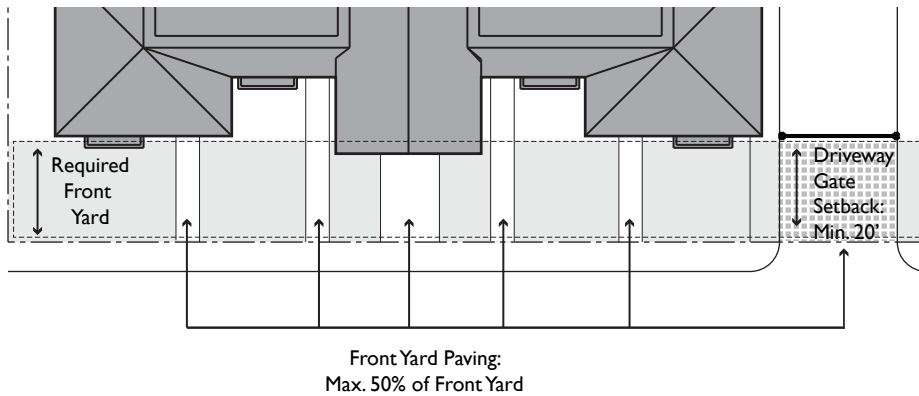
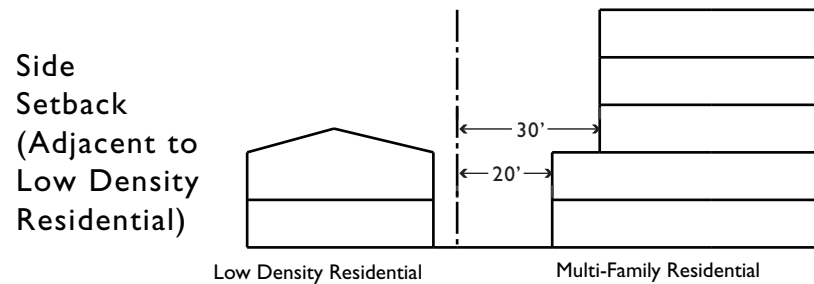
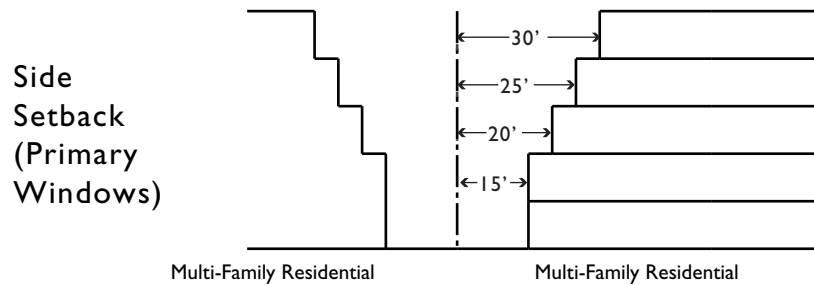
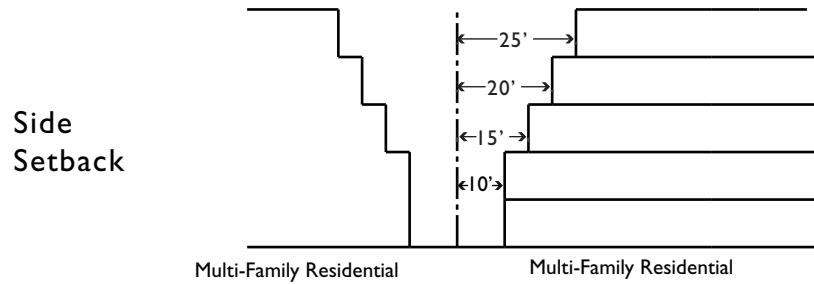

Figure 2.5-5: Multi-Family Residential: Side and Rear Setbacks

**SIDE SETBACK**



**REAR SETBACK**

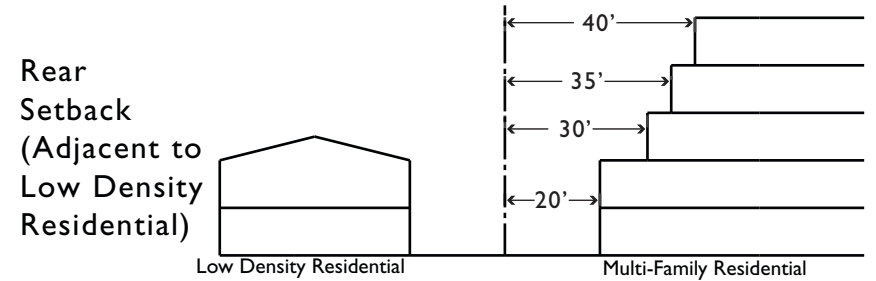
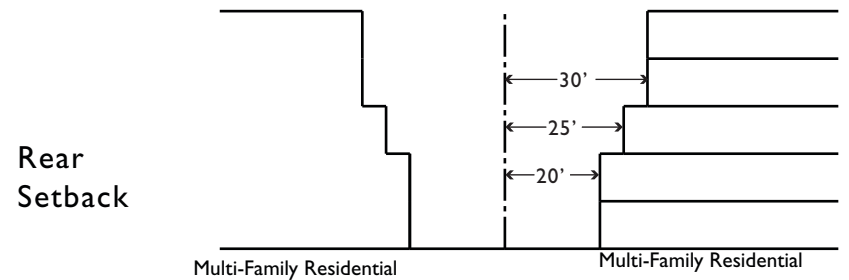
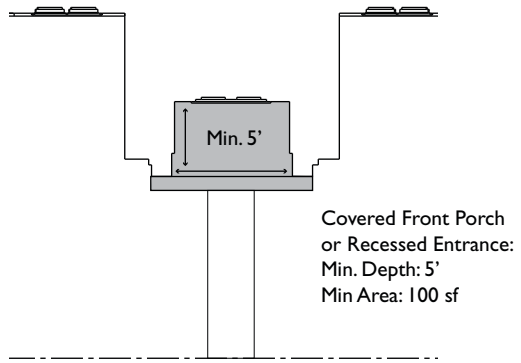

Figure 2.5-6: Multi-Family Residential: Primary Entrance



Private Usable Open Space:  
Min. 75-100 sf/unit

Balcony Dimension: Min. 6' - 7',  
depending on density

Ground Floor Dimension: Min. 10'

Figure 2.5-7: Multi-Family Residential: Open Space

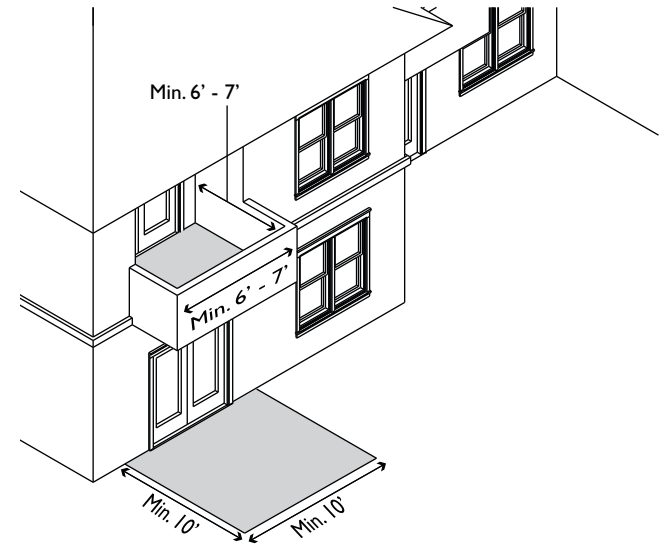

Figure 2.5-8: Multi-Family Residential:  
Front Setback and Elevation above Sidewalk

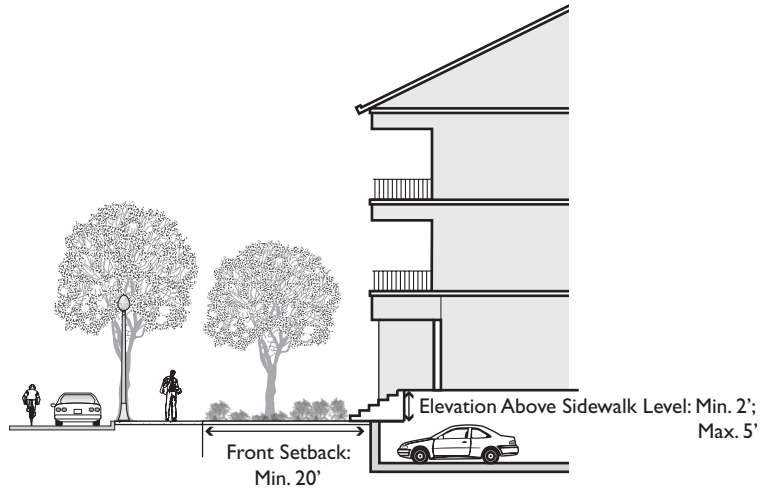

Figure 2.5-9: Multi-Family Residential:  
Height Projections

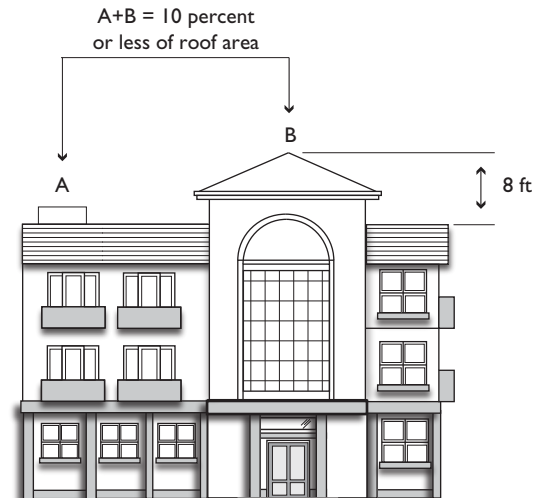
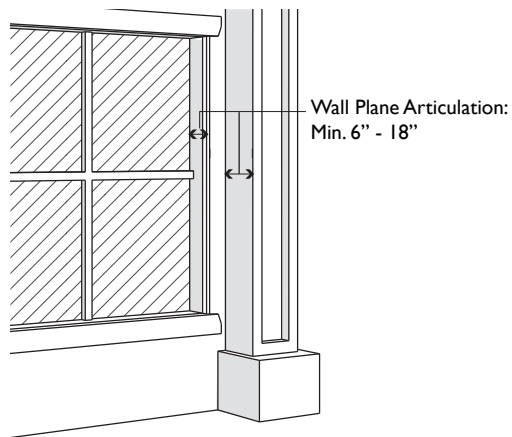

Figure 2.5-10: Multi-Family Residential:  
Ground Floor Articulation



*Page Intentionally Left Blank*

**Table 2.5-1: Multi-Family Residential Standards**

ACBD: Ashland and Cherryland Business District / CVCBD: Castro Valley Central Business District								
<b>Standard</b>	<b>Medium Density Residential</b>					<b>High Density Residential</b>		<b>Additional Standards</b>
	R-3, R-S-D20	R-S-D15, R-S-D3	R-S-DV (with lot width ≥ 100', lot area ≥ 20,000 sq ft), R-S-D3	ACBD-RC	CVCBD Land Use Group D (Subarea 4,5,6,7,11) <sup>1</sup>	CVCBD Land Use Group E (Subarea 8, 9)	R-4	
<b>DEVELOPMENT INTENSITY AND NEIGHBORHOOD COMPATIBILITY</b>								
Minimum Building Site (sq ft)	5,000	5,000	20,000		10,000 - 20,000	20,000	6,000	
Minimum Lot Width (ft)	100	100	100	100	100	100	100	
Minimum Lot Frontage (ft)						100	100	
Maximum Density (dwelling units/net acre)	21.8	29	21.8	15 - 25	17.4 - 21.8; 20 - 40	40 - 60	34.5 - 43.5	For CVCBD Land Use Group D, 20-40 du/ac is allowed in special circumstances. See Multi-Family Residential, CVCBD Land Use Group D in Table 2.1.
Minimum Area per Dwelling Unit (sq ft)	2,000	1,500	2,000		2,500 - 2,000		1,250 - 1,000	For CVCBD, Land Use Group D: 2,500 with minimum lot size of 10,000 – 20,000 square feet 2,000 with minimum lot size of > 20,000 square feet See also Multi-Family Residential, CVCBD Land Use Group D in Table 2.1. For R-S-D3: As specified in the zoning amendment creating the district, in no case less than 1,500 square feet.
Maximum Lot Coverage (%)	55	55	55	55	55	60	60	
<b>BUILDING HEIGHT AND FORM</b>								
Maximum Height (ft)	30	30	30	35	45	45	45	In CVCBD, all buildings with heights greater than two stories or thirty feet must demonstrate through the Site Development Review process that they frame or complement, rather than block, view corridors and that they enhance, rather than obscure, significant topographic features or adjacent development.

Table 2.5-1: Multi-Family Residential Standards

ACBD: Ashland and Cherryland Business District / CVCBD: Castro Valley Central Business District								
<b>Standard</b>	<b>Medium Density Residential</b>					<b>High Density Residential</b>		<b>Additional Standards</b>
	R-3, R-S-D20	R-S-D15, R-S-D3	R-S-DV (with lot width ≥ 100', lot area ≥ 20,000 sq ft), R-S-D3	ACBD-RC	CVCBD Land Use Group D (Subarea 4,5,6,7,11) <sup>1</sup>	CVCBD Land Use Group E (Subarea 8, 9)	R-4	
Height Exception	35	35	35	–	–	55	75	Provided that the portion of the roof over the maximum height allowed is at least 25 feet away from property lines and if the site is not adjacent to R-1 or other low density residential district.  For R-4 District, maximum height of 75 feet only if lot coverage does not exceed 30 percent.
Height Exception (For Projections)	Non-habitable building features such as chimneys (up to 6 feet in width), cupolas, flagpoles, monuments, steeples, roof screens, equipment, and similar structures, covering no more than 10 percent of the top floor roof area to which they are accessory, may exceed maximum permitted height standards by 8 feet.							
Maximum Stories	3	3	3	3	3	4	–	
Stories Exception	–	–	–	–	4	5	–	
Maximum Floor Area (%) (Percentage of First Story Building Footprint Area)	First Story: 100% Second Story: 90% Third Story: 80% Fourth Story (if allowed): 75% Fifth Story (if allowed): 75%							
Maximum Building Length (ft)	150	150	150	150	150	150	150	Exceptions may be approved by Staff if buildings are designed with many different setbacks (instead of a long flat wall), changes in roof form or height, and major recesses (notches) along the length of the building, which successfully break up the massing of the building. Parking podiums may be continuous.
<b>BUILDING RELATIONSHIP TO THE STREET</b>								
Maximum Front Yard Paving (%)	50	50	50	50	50	50	50	
Street Facing Façade Design	Required. Street facing facades must be designed to orient towards the public street. Windows, entry door, and other elements must be incorporated to create an attractive street appearance that is compatible with the surrounding neighborhood.							



Table 2.5-1: Multi-Family Residential Standards

ACBD: Ashland and Cherryland Business District / CVCBD: Castro Valley Central Business District								
<b>Standard</b>	<b>Medium Density Residential</b>					<b>High Density Residential</b>		<b>Additional Standards</b>
	R-3, R-S-D20	R-S-D15, R-S-D3	R-S-DV (with lot width ≥ 100', lot area ≥ 20,000 sq ft), R-S-D3	ACBD-RC	CVCBD Land Use Group D (Subarea 4,5,6,7,11) <sup>1</sup>	CVCBD Land Use Group E (Subarea 8, 9)	R-4	
Building Entrances on Public Street	Required. The principal entry, in the form of individual entrances or aggregated building entrances, shall be located in a visible location facing the public street.							
Principal Entry Projection and/or Recess	Required. The principal entry shall incorporate a projection or recess, or combination of projection and recess.							
Minimum Depth (ft)	5	5	5	5	5	5	5	Alternative designs that create a welcoming entry feature facing the street, such as a trellis or landscaped courtyard entry may be approved by Staff.
Minimum Area of Projection and/or Recess (sq ft)	100	100	100	100	100	100	100	See Figure 2.5-6.
Exception	If entries consist of individual entrances, each individual entrance shall incorporate a projection (e.g. porch) or recess, or combination of projection and recess at least 40 square feet in area, with a minimum depth of five feet.							
<b>GROUND FLOOR BUILDING DESIGN</b>								
Minimum Wall Plane Articulation	Ground floor wall plane articulation shall be a minimum of 6 to 18 inches. Windows, doors, columns, and other features should be recessed or project forward, such that there is a six-inch difference between wall and window surfaces and a total of at least 18 inches from the window to the outermost plane of a wall or column. See Figure 2.5-11.							
Elevation Above Sidewalk Level (ft)								Applies to ground floor living space. See Figure 2.5-8.
Minimum	2	2	2	2	2	2	2	
Maximum	5	5	5	5	5	5	5	
<b>SETBACKS FOR LIGHT, AIR, AND PRIVACY</b>								
Minimum Setbacks (ft)								See Figure 2.5-5.
Front Setback	20	20	20	20	20	20	20	

Table 2.5-1: Multi-Family Residential Standards

ACBD: Ashland and Cherryland Business District / CVCBD: Castro Valley Central Business District								
<b>Standard</b>	<b>Medium Density Residential</b>					<b>High Density Residential</b>		<b>Additional Standards</b>
	R-3, R-S-D20	R-S-D15, R-S-D3	R-S-DV (with lot width ≥ 100', lot area ≥ 20,000 sq ft), R-S-D3	ACBD-RC	CVCBD Land Use Group D (Subarea 4,5,6,7,11) <sup>1</sup>	CVCBD Land Use Group E (Subarea 8, 9)	R-4	
Side	First Story: 10 Second Story: 10 Third Story: 15 Fourth Story (if allowed): 20 Fifth Story (if allowed): 25					10' + 1' for each full 10' by which the median lot width exceeds 50', up to 30'		
Side (For Walls Containing Living Room or Other Primary Room Windows)	First Story: 15 Second Story: 15 Third Story: 20 Fourth Story (if allowed): 25 Fifth Story (if allowed): 30							These setbacks shall apply for any wall containing living room or other primary room windows. When the site is adjacent to a R-1 or R-S district, the project must comply with whichever standard results in the greater setback.
Side (Adjacent to R-1 or R-S District)	First Story: 20 Second Story: 20 Third Story: 30 Fourth Story (if allowed): 30 Fifth Story (if allowed): 30							
Rear	First Story: 20 Second Story: 20 Third Story: 25 Fourth Story (if allowed): 30 Fifth Story (if allowed): 30					10' + 3' for every full 10' by which bldg height exceeds 35'		

Table 2.5-1: Multi-Family Residential Standards

ACBD: Ashland and Cherryland Business District / CVCBD: Castro Valley Central Business District								
<b>Standard</b>	<b>Medium Density Residential</b>					<b>High Density Residential</b>		<b>Additional Standards</b>
	R-3, R-S-D20	R-S-D15, R-S-D3	R-S-DV (with lot width ≥ 100', lot area ≥ 20,000 sq ft), R-S-D3	ACBD-RC	CVCBD Land Use Group D (Subarea 4,5,6,7,11) <sup>1</sup>	CVCBD Land Use Group E (Subarea 8, 9)	R-4	
Minimum Setback From Access Driveway (ft)	5	5	5	5	5	5	5	Must be landscaped.
Minimum Distance Between Buildings (ft)	The minimum distance between buildings shall be 10 feet. The minimum distance shall be increased by 10 feet for each additional story.							
<b>AUTO CIRCULATION: SITE ACCESS AND DRIVEWAYS</b>								
Maximum Access Driveway Width (ft)	20	20	20	20	20	20	20	Staff may approve up to 25 feet for higher density development on busy streets.
Maximum Curb Cuts (number per lot)	1	1	1	1	1	1	1	Exception may be granted by Staff if lot exceeds one acre, lot frontage exceeds 200 feet, or through lot.
Minimum Spacing Between Curb Cuts (ft)				50				
Minimum Driveway Gates Setback (ft)	20	20	20	20	20	20	20	Gates are strongly discouraged. Gates across driveways shall be set back a minimum of 20 feet behind the property line, or greater depending on location in State Responsibility Fire Area and street travel speed.
<b>PARKING LOCATION AND DESIGN</b>								
Maximum Frontage of Parking and Driveways (% of lot frontage)	40	40	40	40	40	40	40	
Maximum Frontage of Parking (% of lot frontage)	30	30	30	30	30	30	30	
Unit Parking (space per unit)	Studio: 1; One Bedroom: 1.5 Two Bedrooms or More: 2							Minimum of one space must be covered. Tandem parking allowed for up to 25 percent of the units.  For CVCBD, lots consisting of more than eight spaces must provide at least 25 percent but not more than 50 percent compact spaces.

Table 2.5-1: Multi-Family Residential Standards

ACBD: Ashland and Cherryland Business District / CVCBD: Castro Valley Central Business District								
<b>Standard</b>	<b>Medium Density Residential</b>					<b>High Density Residential</b>		<b>Additional Standards</b>
	R-3, R-S-D20	R-S-D15, R-S-D3	R-S-DV (with lot width ≥ 100', lot area ≥ 20,000 sq ft), R-S-D3	ACBD-RC	CVCBD Land Use Group D (Subarea 4,5,6,7,11) <sup>1</sup>	CVCBD Land Use Group E (Subarea 8, 9)	R-4	
Transit Corridor Exception	Allow reduced parking for projects that are ½ mile from transit stations of ¼ mile from major transit corridors, through a discretionary review process that includes public notice and opportunity for public input. Transit stations are defined as a BART station, light rail station, or other heavy rail transit station. Major transit corridors are defined as bus corridors with bus rapid transit or corridors with bus service at least every 15 minutes during peak hours and every 30 minutes during daytime hours. Parking reduction may be not allowed if there is existing parking congestion, as defined by the Planning Director, on the street. A parking study may be required to determine existing parking congestion.							
Guest Parking (space per unit)	0.5	0.5	0.5	0.5	0.5	0.5	0.5	
<b>FACILITIES FOR PEDESTRIANS, BICYCLES AND TRANSIT</b>								
Minimum Decorative Driveway Paving (% of Driveway and Parking Area)	10							Locate at driveway entrance, parking areas, and in areas that can be used as open space.
Bicycle Parking	Required. See Chapter 6: Bicycle Parking Standards							
Transit Shelters	On sites that abut a transit corridor (with bus service at least every 15 minutes during peak hours and every 20 - 30 minutes during daytime hours), as requested by the transit agency.							
Public Right-of-Way Improvements	See Specific Plans and Alameda County Engineering Guidelines							
<b>SITE LANDSCAPING</b>								
Minimum Site Landscaping (%)	30	30	30	30	30	25	25	
Minimum Width of Driveway Side Landscaping (ft)	5	5	5	5	5	5	5	Applies between the access driveway and the side and rear property lines.

Table 2.5-1: Multi-Family Residential Standards

ACBD: Ashland and Cherryland Business District / CVCBD: Castro Valley Central Business District								
<b>Standard</b>	<b>Medium Density Residential</b>					<b>High Density Residential</b>		<b>Additional Standards</b>
	R-3, R-S-D20	R-S-D15, R-S-D3	R-S-DV (with lot width ≥ 100', lot area ≥ 20,000 sq ft), R-S-D3	ACBD-RC	CVCBD Land Use Group D (Subarea 4,5,6,7,11) <sup>1</sup>	CVCBD Land Use Group E (Subarea 8, 9)	R-4	
Minimum Parking Area Landscaping	See Chapter 6: Parking Area Landscaping Standards							
<b>USABLE OPEN SPACE</b>								
Minimum Total Usable Open Space (sq ft per unit)	350	350	350	350	300	300	300	
Minimum Common Usable Open Space (sq ft)	1,000 square feet, no less than 100 square feet per unit							Required for projects with five or more units. Common space buildings or covered structures cannot occupy more than 20 percent of common open space.
Minimum Dimension (ft)	25	25	25	25	25	25	25	
Minimum Private Usable Open Space (sq ft)	100	100	100	100	75	75	75	Up to 20 percent of units may not be required to provide private usable open space if they are close to common usable open space and the common usable open space exceeds the minimum required.  Private open space must be open air, not fully enclosed with walls. Private open space cannot be covered by a roof by more than 50 percent of the area; however balconies can have up to 100 percent ceiling coverage.  See Figure 2.5-8.
Minimum Ground Floor Dimension (ft)	10	10	10	10	10	10	10	
Minimum Balcony Dimension (ft)	7	7	7	7	7	6	6	

Table 2.5-1: Multi-Family Residential Standards

ACBD: Ashland and Cherryland Business District / CVCBD: Castro Valley Central Business District								
Standard	Medium Density Residential					High Density Residential		Additional Standards
	R-3, R-S-D20	R-S-D15, R-S-D3	R-S-DV (with lot width ≥ 100', lot area ≥ 20,000 sq ft), R-S-D3	ACBD-RC	CVCBD Land Use Group D (Subarea 4,5,6,7,11) <sup>1</sup>	CVCBD Land Use Group E (Subarea 8, 9)	R-4	
STORAGE								
Storage Areas	Required for all units.							
Minimum Area (cubic ft per unit)	100 cu ft, plus 75 cu ft per bedroom with maximum 250 cu ft total required							
Minimum Dimension (ft)	8	8	8	8	8	8	8	
<p>Notes: Castro Valley Central Business District Subarea 11:</p> <p><sup>1</sup> Medium density residential uses, subject to the provisions of Land Use Group D (High Density Residential) are allowed on properties along Redwood Court, Wilbeam Avenue, Chester Street, Rutledge Road, and Baker Road within 760 feet of Castro Valley Boulevard, which were formerly zoned in an R-3 (Four Family Residence), R-4 (Multiple Residence) District, the various R-S (Suburban Residence) Districts, or a PD (Planned Development) District based on the R-S District, or classified in Land Use Group E (High Density Residential) by the 1983 Plan. In addition, Land Use Group D development is allowed throughout the subarea where all the following conditions are met:</p> <ul style="list-style-type: none"> <li>– The property proposed for development is contiguous for least seventy-five percent (75%) of at least one continuous major property line (which represents at least twenty-five percent (25%) of the total circumference of the property), not including the street frontage, to existing medium density residential or commercial development or the BART station, OR has at least two adjacent street frontages (i.e. be a corner lot) and is contiguous as indicated above or adjacent across the street (not diagonally) to high density residential or commercial development or the BART station; and</li> <li>– The property proposed for development is a regularly shaped parcel (generally rectangular, with a low width:depth ratio, generally 1:2 or lower) at least 20,000 square feet in area, and does not leave an isolated parcel which cannot meet these requirements; and</li> <li>– It has been determined on the basis of an initial study that there will be no adverse impacts on surrounding development, including but not limited to traffic, visual, noise, privacy, or others, or that such impacts can be mitigated to an acceptable level and such mitigation measures are incorporated into the project through a mitigated negative declaration or environmental impact report. (Castro Valley Business District Specific Plan, p. 70-71)</li> </ul>								